

KD STORAGE SYSTEM



IDEAL FOR YOUR FILLING NEEDS

The KD Storage System allows you to save space by selecting storage modules based on your chosen document size. Also, you can use it as a partition to gently separate a workplace.



UTILIZABLE ELEGANCE

Two base color options available. You can create a unique office space that matches your needs.

Function

Not only can your files and documents be searched easily, the KD Storage System also incorporates a number of security features. In addition, the system is designed with earthquake countermeasures.



Lateral Filing Cabinet

Accommodates up to A4-size files, with three dividers per drawer. Latched drawers remain closed in the event of an earthquake.

Maximum load capacity: 40kg



Triple Sliding Door Storage

Offering a wider opening than the double sliding doors, these doors allow for convenient access to the middle section and storing larger items.

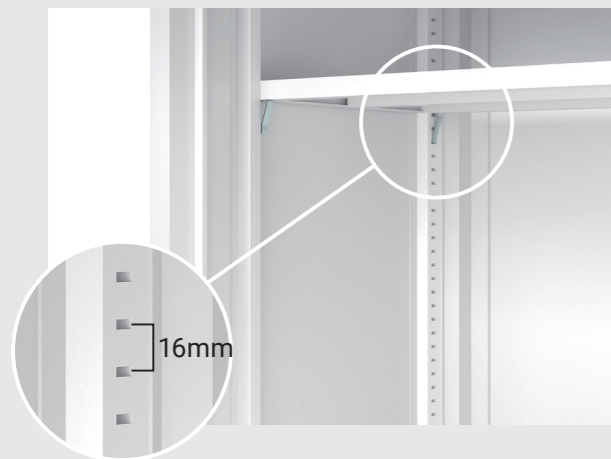

Adjustable Shelves

The shelves are easily adjustable in 16mm intervals to allow for storage of different sized items.

Maximum load capacity: 40kg



Double Hinged Doors (180°)

Convenient access to files.

The hinged doors open 180 degrees without blocking aisles.

Safety Lock Mechanism

In order to prevent tipping from a unbalanced load, a safety lock mechanism prevents more than one drawer from being opened at once.

All-Lock Mechanism

The all-lock mechanism prevents opening of all the drawers.

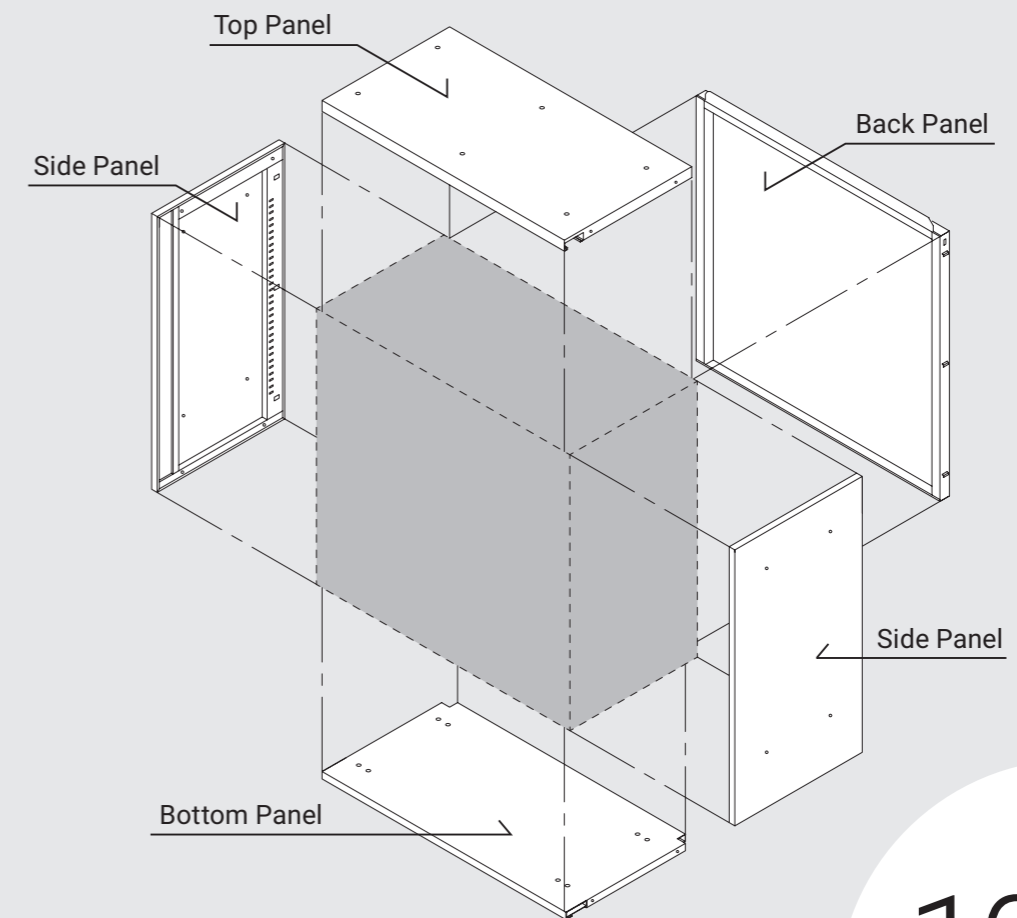
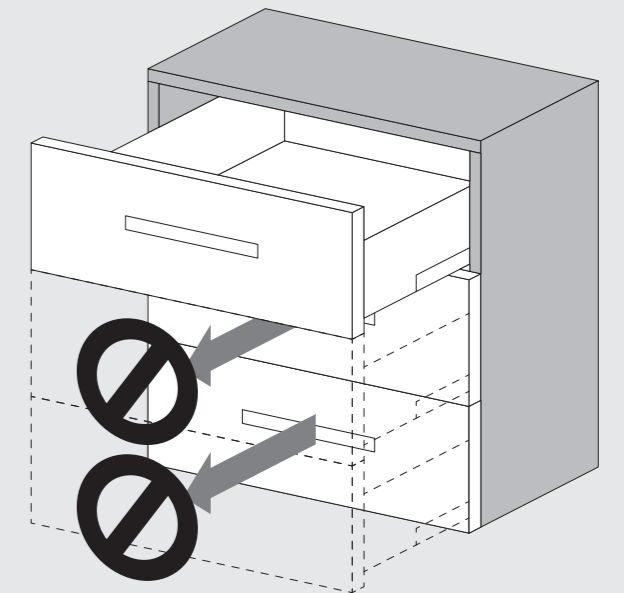

Assembly Combination & Knockdown Structure

The Knockdown structure of the KD Storage System makes for simple assembly or dismantling, allowing simple installation and/or disposal [does not apply to the lateral file cabinet or crystal case].

100%
RECYCLABLE
KD Storage Made of Steel

Dimension

Type	Double Hinged Doors	Steel Sliding Doors	Glass Sliding Doors	Shelving	Divider Shelving	Lateral Filing	
Image							
Width	900 (864)				900 (399)	900 (823)	
Depth	450 (396)	450 (373)	450 (373)	450 (421)	450 (373)	450 (390)	
Height	1 Level	300 (246) 8VT30D	—	—	—	—	—
		400 (346) 8VT40D	—	—	—	—	—
	2 Level	700 (646) 8VT70D	700 (638) 8VT70L	700 (638) 8VT70G	700 (638) 8VT70S	—	700 (302)*1 8VTR20
		800 (746) 8VT80D	800 (738) 8VT80L	800 (738) 8VT80G	800 (738) 8VT80S	—	—
	3 Level	1000 (946) 8VT10D	1000 (938) 8VT10L	1000 (938) 8VT10G	1000 (938) 8VT10S	—	—
		1050 (996) 8VT15D	1050 (988) 8VT15L	1050 (988) 8VT15G	—	1050 (988) 8VT15V	—
		1100 (1046) 8VT11D	1100 (1038) 8VT11L	1100 (1038) 8VT11G	1100 (1038) 8VT11S	—	1100 (302)*2 8VTR30
		1200 (1146) 8VT12D	1200 (1138) 8VT12L	1200 (1138) 8VT12G	1200 (1138) 8VT12S	—	—
	5 Level	1800 (1746) 8VT18D	—	—	1800 (1738) 8VT18S	1800 (1738) 8VT18V	—
	6 Level	2100 (2046) 8VT21D	—	—	2100 (2038) 8VT21S	—	—

() = Inside Size

*1: 700H (2 Level) of Lateral Filing does not include a base unit
*2: 1100H (3 Level) of Lateral Filing includes a base unit (H100)

Capacity by Filing (A4S Binder)

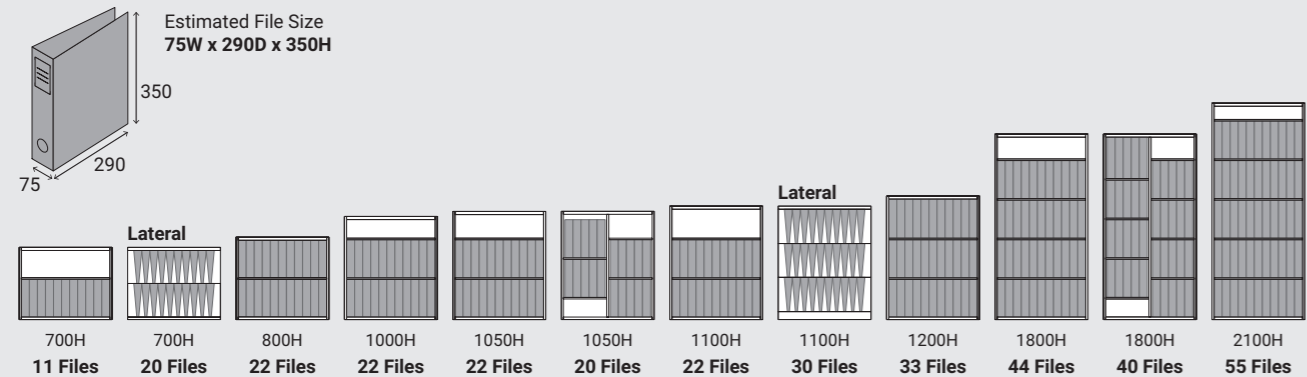

*The 400H type is not compatible with the A4S binder.

Island Storage Module

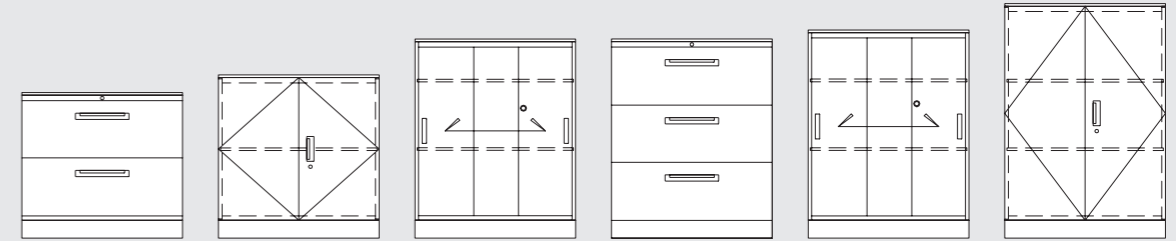

Total	821	921	1121	1121	1171	1321
Top Board	21	21	21	21	21	21
Storage	700	800	1000	1100*	1050	1200
Base	100	100	100	—	100	100

(H)

* The lateral comes with an included base

*Please note that a top panel is required when using the module under a height of 1500H

Wall-compatible Module

*An example of a part of the combinations.

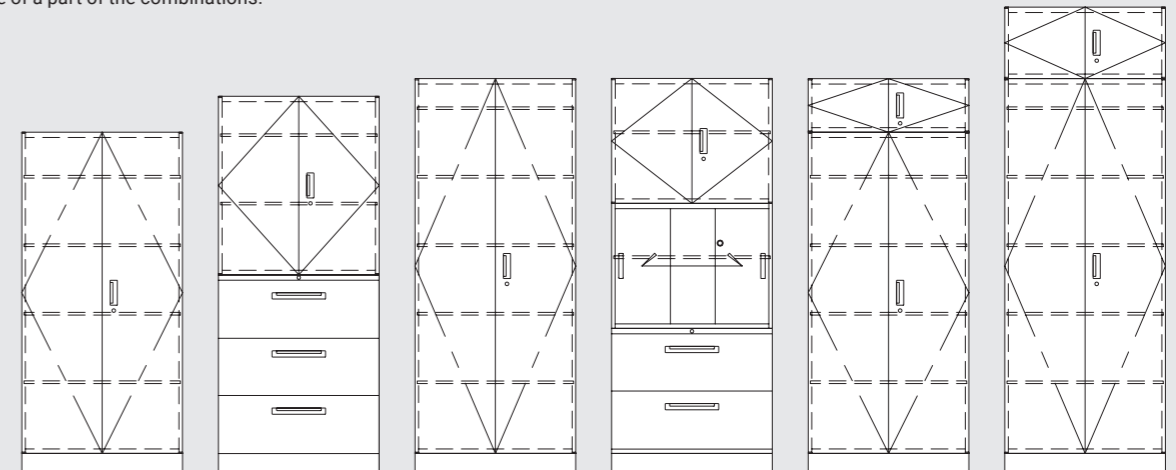

Total	1900	2100	2200	2200	2200	2600
Top Board		1000			300	400
Storage	1800	1100*	2100	700 (x3)	1800	2100
Base	100	—	100	100	100	100

(H)

* The lateral comes with an included base

Option



Wardrobe Shelf
8VT226Y-Z □□□



Book End (Large Size)
8VTPHZ-Z □□□ :
1 set (5 pcs.) 180Hx300D

Book End (Small Size)
8VTPGZ-Z □□□ :
1 set (5 pcs.) 90Hx300D

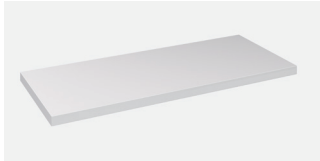

Top Panel
8VT12AZ-M □□□ : 900Wx450Dx21T

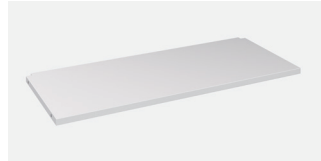

Shelf
8VTSHE-Z □□□ : 900Wx378Dx15T
1 set (Shelf x 1 pcs. / Shelf Support x 4 pcs.)

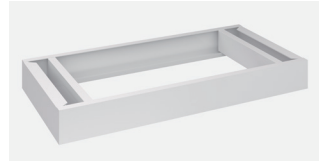

Base Unit
8VTAZZ-Z □□□ : 900Wx450Dx50H
8VTBZZ-Z □□□ : 900Wx450Dx100H



Coping Unit
8VT141Y-Z □□□ : 65H - 110H
8VT142Y-Z □□□ : 110H - 200H
8VT143Y-Z □□□ : 165H - 250H

Color Variation

To meet your interior design needs, the double sliding glass door, double hinged door, triple sliding door and lateral file cabinet storage units are all available in the colors below.

Storage



ZA75W
Neo White



ZA75B
Neo White/Black



Z25B
Black

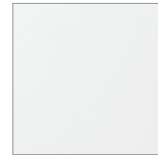

MBP9
Milky White

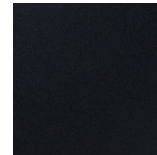

MBP8
Black (Anti-Fingerprint)



MMA7
Natural Oak



MFA6
Medium Walnut



MBK9
Dark Walnut

OKamura

Okamura International (Singapore) Pte Ltd
www.okamura.com.sg

Okamura International Malaysia Sdn. Bhd.
www.okamura.jp

Siam Okamura International Co., Ltd.
www.okamura.co.th

PT. Okamura Chitose Indonesia
www.okamura.com/en-ap/

Okamura International Vietnam Co., Ltd.
www.okamura.com.vn

The products listed in this catalog are available as of May 2024. Please note that specifications, dimensions, and colors are subject to change without notice. The colors of the actual products may differ somewhat from the colors shown in the catalog, depending on printing conditions.