

OKAMURA INTERNATIONAL VIETNAM CO., LTD.

HCMC

Location Suite 1104B, 11th Floor Saigon Tower, 29 Le Duan St., Ben Nghe Ward,
District 1, HCMC, Vietnam

Tel +84-28-3822-6392

HANOI

Location CP2.L.02, 19 Floor, Capital Place, No 29 Lieu Giai St., Ngoc Khanh Ward,
Ba Dinh District, Hanoi City, Vietnam

Tel +84-24-7300-6879

E-mail marketing@vn.okamura.com

okamura.com.vn



The products listed in this catalog are available as of September 2024.
Please note that specifications, dimensions, and colors are subject
to change without notice. The colors of the actual products may
differ somewhat from the colors shown in the catalog, depending on
printing conditions.

okamura

VOL. 10

Loving
people,
creating
places

okamura



Loving people, creating places

To increase the number of people who can live their lives in their own way, and to build a society full of smiles, Okamura will continue loving people and creating places where they can thrive.



Okamura was established in 1945 by a group of engineers. Mikasa, Japan's first automatic front wheel drive car, developed by Okamura in 1955. The spirit of craftsmanship contributes to an environment where working people can thrive.

INTRODUCTION OF OKAMURA



79
YEARS
IN BUSINESS



3,844
EMPLOYEES



OVER
USD 2.4 BN
SALES
(CONSOLIDATED)



34
GROUP
COMPANIES



OVER
50
COUNTRIES
DISTRIBUTED



703
DESIGN
AWARDS

1945 Okamura founded in
Yokohama City, taking
the name of its location
in Okamura Town.



'48 Started manufacturing
garden tables and chairs.

'50 Began production of
torque converters for
trains, cars, and
industrial vehicles.



'58 Oppama Plant
established.

'57 Steel office desks and
chairs launched



'55 Developed Japan's first
front-wheel-drive
automatic, the Mikasa.

'53 The N-52, Japan's
first postwar airplane,
completed.



'69 Began sales of Japan's
first colored desks and
chairs, the Type-33 and
the Type-21.

'70 Tokyo showroom opened



'86 Ergonomic chair
launched



'09 Okamura Museum
opened.



'08 Chicago Showroom
opened. Participated in
NeoCon 2008.

'02 Contessa ergonomic
mesh chair announced.



'96 Siam Okamura
International Co., Ltd.
established in Thailand.

'20 Okamura International
Vietnam Co., Ltd.
established.



'22 Ha Noi branch
established

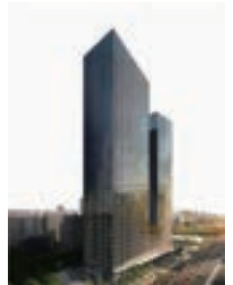

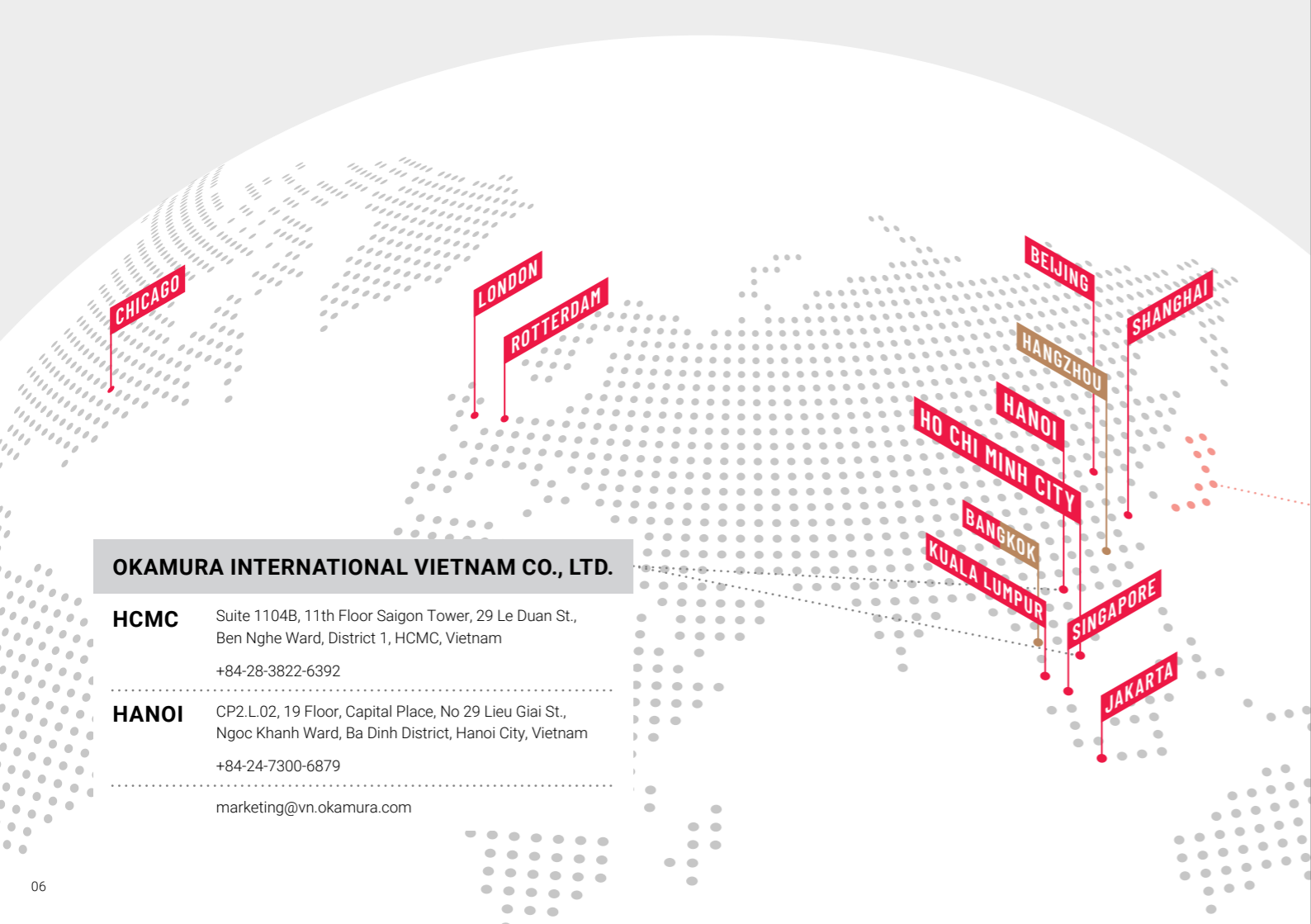

OKAMURA INTERNATIONAL VIETNAM CO., LTD.

HCMC Suite 1104B, 11th Floor Saigon Tower, 29 Le Duan St., Ben Nghe Ward, District 1, HCMC, Vietnam
+84-28-3822-6392

HANOI CP2.L.02, 19 Floor, Capital Place, No 29 Lieu Giai St., Ngoc Khanh Ward, Ba Dinh District, Hanoi City, Vietnam
+84-24-7300-6879
marketing@vn.okamura.com

13 MAIN OFFICE
10 FACTORY

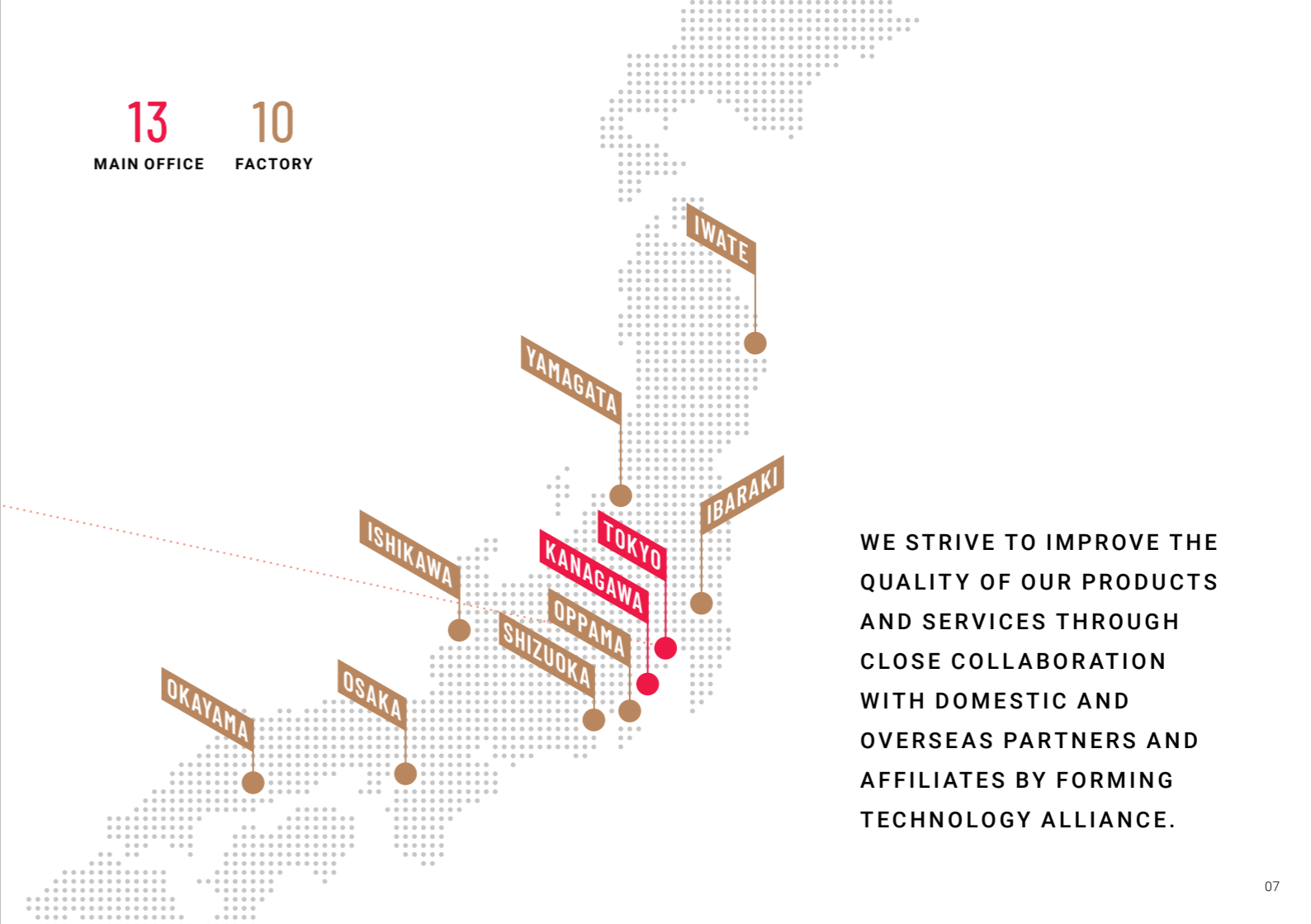

WE STRIVE TO IMPROVE THE QUALITY OF OUR PRODUCTS AND SERVICES THROUGH CLOSE COLLABORATION WITH DOMESTIC AND OVERSEAS PARTNERS AND AFFILIATES BY FORMING TECHNOLOGY ALLIANCE.



HCMC SHOWROOM

Suite 1104B, 11th Floor Saigon Tower, 29 Le Duan St., Ben Nghe Ward, District 1, HCMC, Vietnam

HANOI SHOWROOM

CP2.L.02, 19 Floor, Capital Place, No 29 Lieu Giai St., Ngoc Khanh Ward, Ba Dinh District, Hanoi City, Vietnam

SUSTAINABILITY POLICIES AT THE OKAMURA GROUP

THROUGH OUR MISSION AT THE OKAMURA GROUP, "CONTRIBUTE TO SOCIETY BY CREATING ENVIRONMENTS WHERE PEOPLE CAN THRIVE WITH RICH IDEAS AND RELIABLE QUALITY", WE AIM FOR ENHANCED CORPORATE VALUE AND PROVIDING SOLUTIONS TO ISSUES FACING SOCIETY.

ANSI/BIFMA X5.5 **ANSI/BIFMA X5.1**

American National Standard
for Office Furnishings
• Desk Products



BIFMA's Sustainability
Certification Program
for Furniture



Indoor Air Quality
Certification for Furniture
and Building Materials

Further Info.



AWARDS



WARRANTY PERIOD

The following cases are excluded from the warranty;

- Due to wear and tear caused by normal use
- Damage to cloth, mesh, etc. due to human factors
- Products customized or modified locally

*The warranty period for Vietnamese products is one year.

10
YEARS

Structural components, including frames, shells, bases, operating mechanisms including adjustable armrest

5
YEARS

Casters, gas cylinder, adjusters and adjustment levers

2
YEARS

Coating finish, mesh & fabric, cushions, and arm pads

**20 YEARS
OF
OKAMURA
WITH
ITALDESIGN**



Contessa 20th Anniversary

Leading furniture manufacturer, Okamura, joined forces with Turin-based design firm, ITALDESIGN in 2000, to create a world class office chair. Two years later, Contessa emerged, an instant classic. Contessa's form celebrates contrast. The sheer, transparent tension of stretched mesh across the seat and back provides an elegant counterpoint to the sleek, industrial weight of the aluminum frame. Iconic and enduring looks, with outstanding ergonomic functionality, have ensured this task chair quickly earned global acclaim. For the past 20 years, Contessa has remained a favorite in office seating.

Special Website



The Industrial Design Division of Italdesign, headquartered in Moncalieri, Torino – Italy, was established in 1981 and today is one of the most renowned and leading organizations in the industrial and transportation design fields on a worldwide level. Acclaimed for its proclivity in all-round functional design, Italdesign's projects range from automobiles to pieces of furniture, from tires to watches and home appliances.



2002 *Contessa* 2004 *Baron* 2010 *Luce* 2012 *Sabrina* 2016 *Contessa II seconda* 2018 *Finora* 2022 *Contessa 20th Anniversary*



OKAMURA MATERIALS



MESH WITH KAWASHIMA SELKON TEXTILES

Okamura's mesh by Kawashima Selkon Textiles, rooted in Nishijin-ori - a traditional type of weaving unique to Kyoto, Japan, has evolved in various ways design wise. Naturally, everything from material procurement, to mesh construction and chair assembly takes place in Japan. It's this 'Made in Japan' quality that makes our mesh seating so special.



FABRIC WITH KVADRAT

Okamura and Kvadrat were united by a shared quest to create the highest quality and beautiful designs. Together we will continue to make work environments more creative and pleasing, by elevating the seating to the level of an exquisite, yet hardworking piece of art.

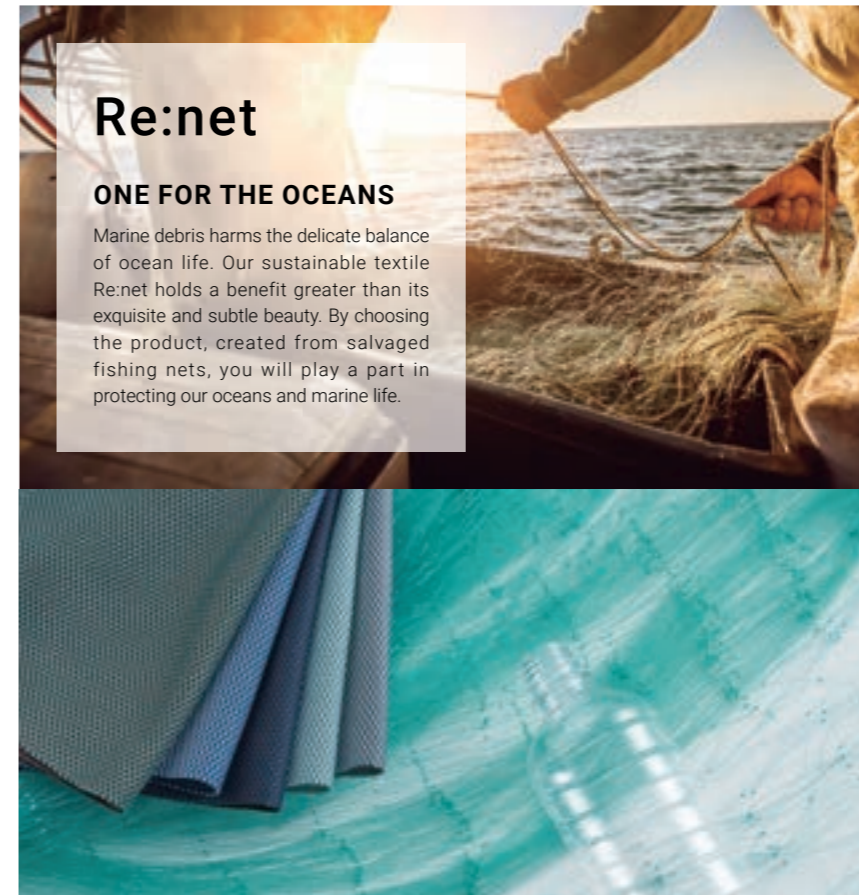

Re:net

ONE FOR THE OCEANS

Marine debris harms the delicate balance of ocean life. Our sustainable textile Re:net holds a benefit greater than its exquisite and subtle beauty. By choosing the product, created from salvaged fishing nets, you will play a part in protecting our oceans and marine life.



INNOVATING FOR A BETTER WORKPLACE

From concept to completion, Okamura products are brimming with the creative spirit. Even the smallest details push the boundaries of conventional design, so we create something entirely new and wholly unique, again and again. All with the end goal to evolve the workplace, creating more productive, more creative, and happier environments.

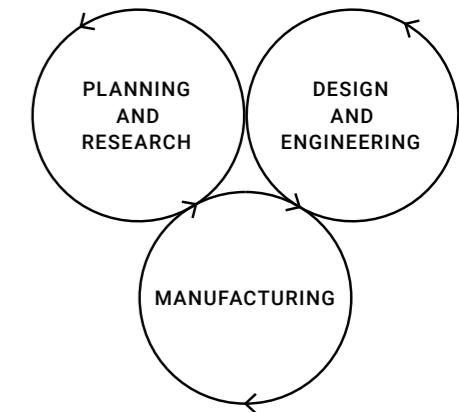

POSTURE

EXECUTIVE CHAIR

Legender
Shibusa
Contessa II •
Choral •

TASK CHAIR

Sphere
Finora •
Sabrina Standard
Sylphy •
Portone Smart •
Rin •
Primp •

MULTI-PURPOSE CHAIR

Plimode
Lives Work Chair
Cynara •
e.n.a.
MC (Marca)
Runa
T1
81T2 •
Repiroue •

• = Stock in HCMC





Legender

Made in Japan

Legender is the ultimate executive chair. A combination of functionality, class and elegance, drawing upon our expertise in ergonomics and our long tradition of creating beautiful furniture. Soft and supple leather and world class design, for the world's leading executives.

Product Info.

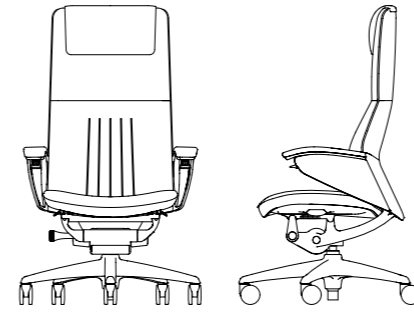

Color



Dimensions

Extra High Back :
W686 × D575-625 × H1201-1311

High Back :
W686 × D575-625 × H1051-1161

**ANSI/
BIFMA
X5.1**





SHIBUSA

Made in Japan

Simplicity, implicit, modesty, naturalness, everydayness, imperfection, and silence. In these traits, one discovers the Japanese aesthetic philosophy of Shibusa.

Suspended in the balance between simplicity and complexity, restraint and spontaneity, SHIBUSA by Okamura represents understated elegance and quiet confidence.

Product Info.

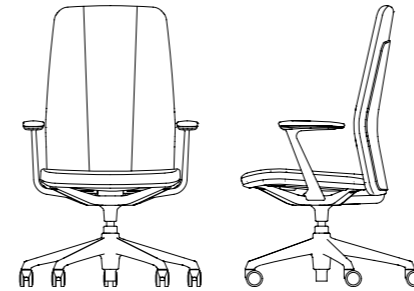

Color



Dimensions

High Back :
W650 × D575 × H1050-1160

Mid Back :
W650 × D556 × H940-1050

ANSI/
BIFMA
X5.1





Contessa II *seconda*

Made in Japan | Stock in HCMC

Since debuting on the world stage in 2002, the highly regarded Contessa has been reborn.

While the elegant lines of Contessa's original form have been maintained, the chair's functionality has been upgraded to meet the needs of our diverse global customers.

Product Info.

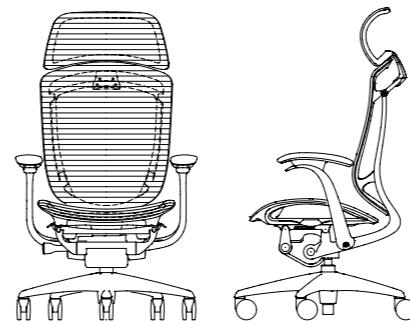

Color



Dimensions

Extra High Back :
W650-702 × D620-670 × H1170-1270

High Back :
W690 × D570-620 × H980-1080

ANSI/
BIFMA
X5.1





Choral

Made in Japan | Stock in HCMC

Choral's name symbolizes the concept of a "perfectly tuned chair" - ergonomically tuned to your body and aesthetically tuned to the office. This simple approach has achieved a timeless design and dynamic beauty that is harmonized to complement a multitude of office environments.

Product Info.



Color



Dimensions

Extra High Back :
W660-710 x D577-627 x H1170-1370

High Back :
W660-710 x D577-627 x H981-1081

ANSI/
BIFMA
X5.1





Sphere

Made in Japan

The casual light seating favored in shared settings is only intended for short duration sits. But behaviorally, on their office days, workers still tend to settle in for longer. Even if highly specified task chair is provided, very few workers take the time to make the beneficial micro adjustments, each time they settle in. Sphere has been designed to eliminate this compromise.

Product Info.

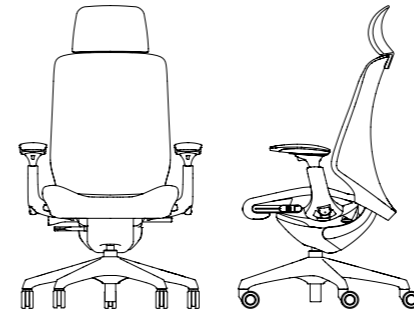

Color



Dimensions

W700 x D700 x H966-1066

ANSI/
BIFMA
X5.1





Finora

Made in Japan | Stock in HCMC

Elevate your work in the uncompromised beauty of lightness.

Finora was designed to encapsulate beauty with streamlined thinness and lightness. By applying the design philosophy that is distinctive to the automotive industry, Finora provides the modern worker with a high level of functionality for the ultimate level in comfort in an office chair without sacrificing the esthetic design.

Product Info.

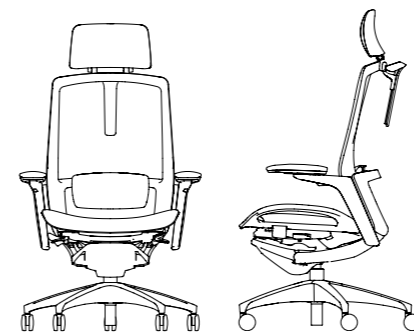

Color



Dimensions

High Back :
W690-740 × D540-590 × H970-1070

Mid Back :
W640 × D540-590 × H910-1010

ANSI/
BIFMA
X5.1





Sabrina

Standard

Made in Japan

You can see this iconic ring structure not just in back view but from front view through permeable mesh back for which you have ample color variation to choose from.

Welcome to the Sabrina world of the beautiful marriage between state-of-the-art technology and a world-renowned design.

Product Info.

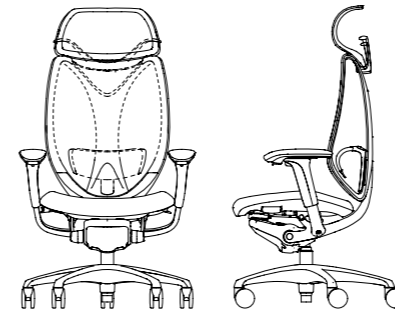

Color



Dimensions

Extra High Back :
W695 × D570-620 × H1190-1290

High Back :
W650 × D570-620 × H1185-1315

**ANSI/
BIFMA
X5.1**





Sylphy

Stock in HCMC

Okamura understands that people's backs are all shaped differently. To accommodate these differences, Sylphy provides superior comfort — as if the backrest were custom-made for you. Sylphy fits every member of your office.

Product Info.



Color



Dimensions

High Back with Headrest :
W648 × D658-708 × H1153-1283

High Back :
W642 × D574-624 × H960-1090

ANSI/
BIFMA
X5.1





Portone Smart

Made in China | Stock in HCMC

The union of style and comfort. The pliable frame harmonizes with your movement as the lumbar support comfortably contours the curves of your back. A design born of Okamura's fascination with ergonomics.

Product Info.



Color



Dimensions

Extra High with Headrest :
W656 x D560-610 x H1130-1300

High Back :
W656 x D560-610 x H970-1090

ANSI/
BIFMA
X5.1





Rin

Made in Thailand | Stock in HCMC

An ergonomic mesh chair named after the Japanese word which translates to 'a dignified state of being'. Designed based on Okamura's own research into ergonomics, Rin is a chair that provides a comfortable seating experience and helps maintain ideal posture.

Product Info.



Color



Dimensions

High Back with Headrest :
W650 x D561 x H1190-1290

High Back :
W650 x D558 x H975-1075

ANSI/
BIFMA
X5.1





Primp

Made in China | Stock in HCMC

The quality of a chair is measured by the level of comfort you'd experience after sitting in it for long periods of time. Primp is a basic chair that supports your back with a soft mesh fabric, giving you nice comfort. Backed up by Okamura's strong DNA in engineering, Primp freshens up the office ambiance with smart design.

Product Info.



Color



Dimensions

W485 x D540 x H868-988

ANSI/
BIFMA
X5.1





plimode

Made in Japan

Plimode helps you maintain optimal posture, leaving you refreshed and invigorated. Admire the attention to quality in every stitch and detail, from the chair's fit to the final finish. Plimode is imbued with 70 years of Okamura craftsmanship and design.

Product Info.

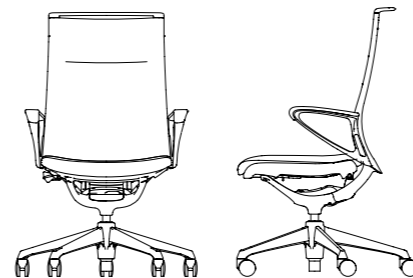

Color



Dimensions

High Back :
W605 x D577 x H1000-1110

Mid Back :
W630 x D573 x H935-1045

**ANSI/
BIFMA
X5.1**





Lives Work Chair

Made in Japan

Today's office chairs demand more than functionality. Relaxed, residential-feel spaces create work environments where workers express themselves and thrive. Lives Chairs bring a casual look to the office and are equipped with the state of the art features that employees have come to expect.

Product Info.

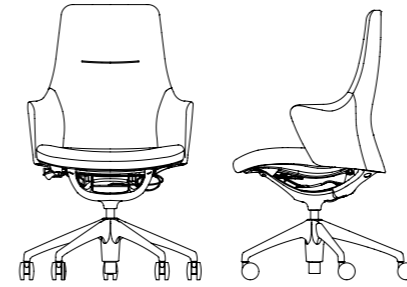

Color



Dimensions

High Back :
W582 x D560 x H956-1056

Low Back :
W582 x D530 x H856-956

**ANSI/
BIFMA
X5.1**





CYNARA

Made in Japan | Stock in HCMC

Experience the impossible lightness and effortless support of Cynara, a task chair that integrates intuitive, responsive functionality with a clean-cut, refined aesthetic to complete any work setting.

Product Info.

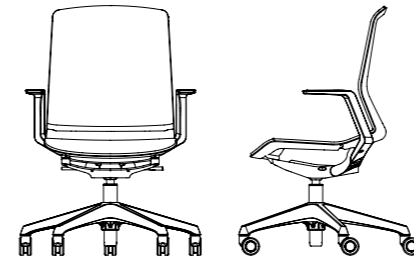

Color



Dimensions

W610 x D500 x H914-1024

ANSI/
BIFMA
X5.1





e.n.a.

Made in Japan

Targeting co-creation spaces that require stylish solutions, e.n.a. was born from our collaboration with ITO Design where the goal was to create a chair that could represent Okamura's existing lineup.

Product Info.

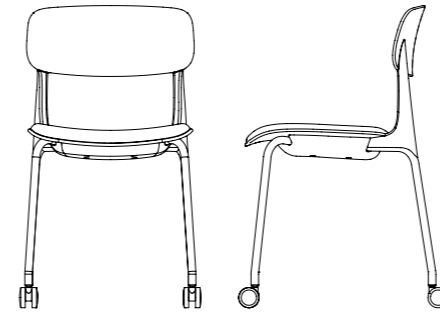

Color



Dimensions

W424 x D529 x H779

**ANSI/
BIFMA
X5.1**



MC

Made in Japan

Sharp frame, supple sitting comfort, excellent storage capacity. Marca, the high-quality and delicate design along with human-friendly functions provides new value to the meeting scene.

Color



Dimensions

W590 × D570 × H820

Product Info.



ANSI/
BIFMA
X5.1



Runa

Made in Japan

Simplistic design that embodies the functional needs of versatile office environment. "Runa" offers a comprehensive seating collection with a wide variety of colors and finishes. When you need freedom to think creatively and want those big ideas, "Runa" gives you that freedom and support to succeed.

Color



Dimensions

Basic :
W562 × D560 × H837

Product Info.



ANSI/
BIFMA
X5.1



T1

Made in Japan

Simple yet chic and comfortable, T1 is an attractive choice for every meeting. Its beautiful design and comfortable functionality unites a range of possibilities. With a cantilever structure and mesh backrest, T1 conforms to the shape of your body. Comfort and style truly come together in the T1.

Color



Dimensions

W576 × D628 × H867

Product Info.



81T2

Made in Thailand | Stock in HCMC

This meeting chair features both stacking and nesting storage options, while also realizing superior comfort.

Color



Dimensions

W590 × D540 × H783

Product Info.



ANSI/
BIFMA
X5.1





repiroue

Made in Japan | Stock in HCMC

Okamura recommends five postures for increased office productivity and efficiency. Among them is the perching posture, a perfect combination of standing and sitting, which is suitable for a standing meeting or a touchdown. Our perching stool, repiroue was brought to life with the intention of making the perching posture more accessible in the office environment.

Product Info.

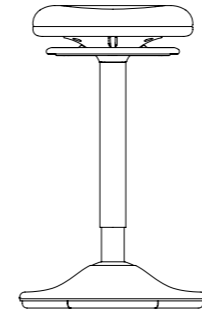

Color

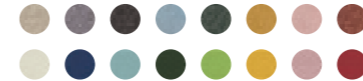

Dimensions

Φ350 × H565-815

ANSI/
BIFMA
X5.1



WORK STATION

Traverse

Traverse Satellite

Precede

Oree

Workflex **NEW**

SW (Swift)

Soliste

VD-A Desk •

Risefit III

Flaptor-A •

• = Stock in HCMC





traverse

Made in Japan

In today's workplace, conference rooms are challenged with shrinking size as well as the need to adapt to evolving technologies. Traverse is a collection of two conference tables defined by narrow contours that broaden office space, bringing people together beautifully.

Product Info.

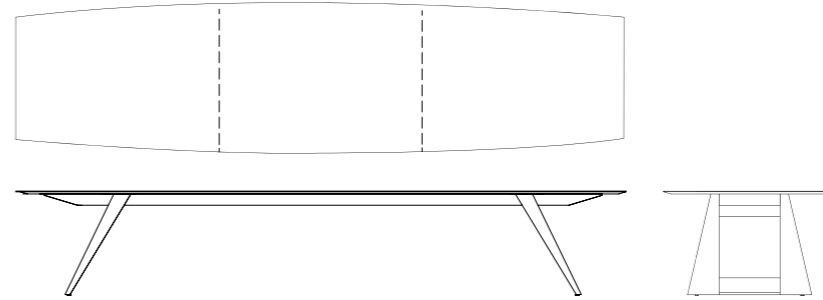

Color



ANSI/
BIFMA
X5.5





traverse satellite

Made in Japan

Conference rooms and the tables around which we gather are changing. They have become a gathering place for collaboration, from informal to formal, small to large groups. The newest member of the Traverse table collection —traverse satellite — offers Okamura's incomparable attention to detail and engineering-forward design, at a size appropriate for smaller conference rooms and offices.

Product Info.

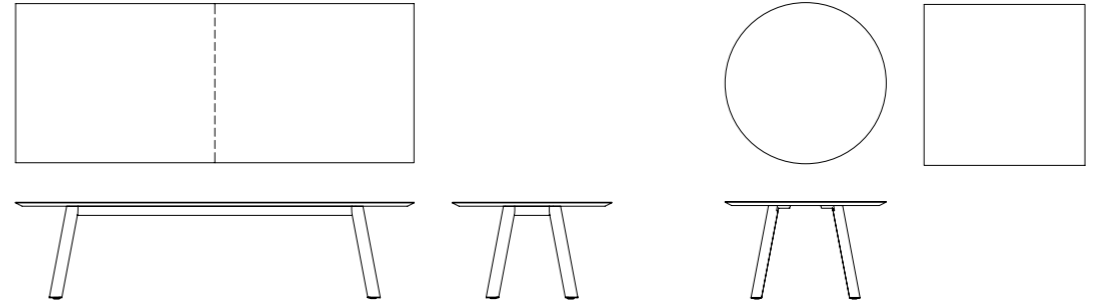

Color



ANSI/
BIFMA
X5.5





PRECEDE

Made in Japan

PRECEDE is an office system furniture that covers all spaces such as work spaces, meeting areas, executive rooms and several others. Sleek polished metal legs, warm wood grain finishes, desks and tables with sophisticated forms and comfortable textures bring out diversity within an organization and at the same time foster a sense of team solidarity.

Product Info.

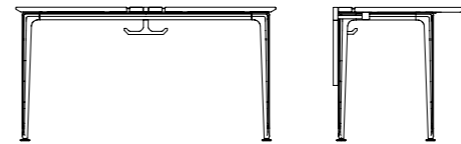
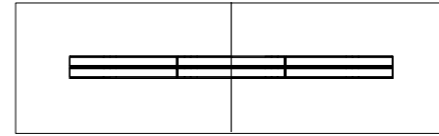

Color

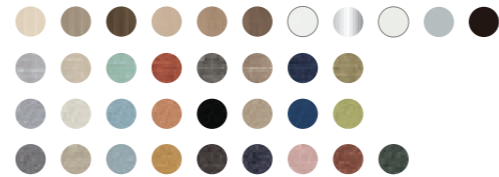



OREE

Made in Thailand

OREE signifies a point that infuses simplicity and strength while drawing inspiration from Japanese origami.

With origins in Japan, origami art combines defined shapes and edges, to bring forth artistic structures. Fusing Okamura's skilled sheet metal technology with folds of thin sheet metal creates a beautiful and strong foundation.

Product Info.

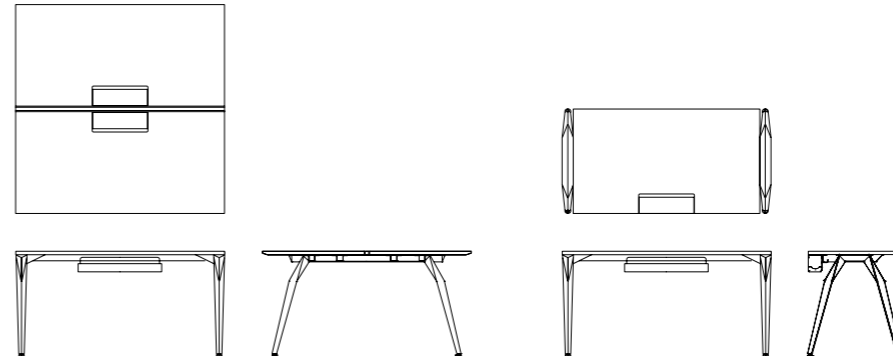

Color



ANSI/
BIFMA
X5.5





Workflex

Made in Thailand

The traditional fixed location work style in which each worker has their own desk has been replaced by a new style of working where workers are free to change locations depending on the nature of the task they are working on. As the name suggests, Workflex is a desk system that brings flexibility to the way you work.

Product Info.

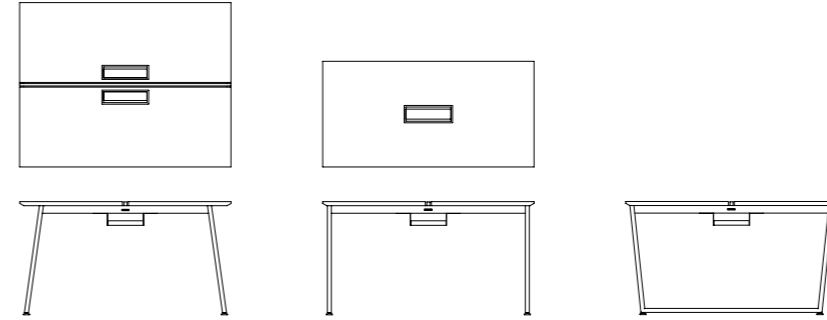

Color



ANSI/
BIFMA
X5.5





SW

Made in Japan

Move the surface of the desk up or down quickly and with ease, creating the optimum positioning for the worker when it's needed. With full focus on freed movement, comfort and safety, this flexible SW is a fusion of design and functionality.

Color

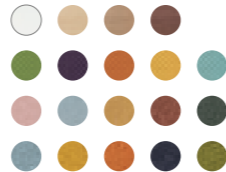

Product Info.



ANSI/
BIFMA
X5.5



SOLISTE

Made in Thailand

SOLISTE is a new concept in desks developed for the office of the future. Its simple design, with narrow top and elegant, slim legs, makes it beautiful when used alone, but it can also be used in pairs without feeling overwhelming, creating an open and sophisticated working space.

Color



Product Info.



ANSI/
BIFMA
X5.5



VD - A Desk

Made in Thailand | Stock in HCMC

With the rapid development of mobile tools and the impact this has on work style, the demands on office space and office furniture are changing. Changes in work styles • activity-based working (ABW) are expected to further advance. It is expected that working styles will continue to diversify in the future, and Okamura is introducing the "New Office Series" tailored to such office trends.

Product Info.

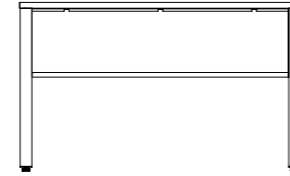

Color



ANSI/
BIFMA
X5.5





Risefit III

Made in Japan

Risefit III is a versatile supplementary work table that can be used in any part of your company's office, lobby, or lounge. Its height can be continually readjusted to meet the needs of any particular user at any time, whether sitting or standing.

Color



Product Info.



ANSI/
BIFMA
X5.5



FLAPTOR-A

Made in Thailand | Stock in HCMC

Folding table Flaptor A is designed as a parallel nesting table. It realizes space saving and beautiful storing. The square pipe legs and frame support the table's luxurious design, stability and durability.

Color



Product Info.



LOUNGE & MODULAR

Nagare

Lives Work Lounge Chair

Lives Pouf

Alt Living

Drape

Chatbox by Silen

Lives Shelf

Sprint

Posit-A

5°GO-DO





NAGARE

Made in Japan

Nagare, which means 'flow' in Japanese, is a new collection of lounge furniture that responds to the way we work today. Nagare consists of two distinct families – NAGARE Lounge and NAGARE Platform – each element possesses a sculptural quality that makes a bold aesthetic statement, while also being highly functional. This new collection has been carefully designed to help us work more effectively wherever work might happen.

Product Info.

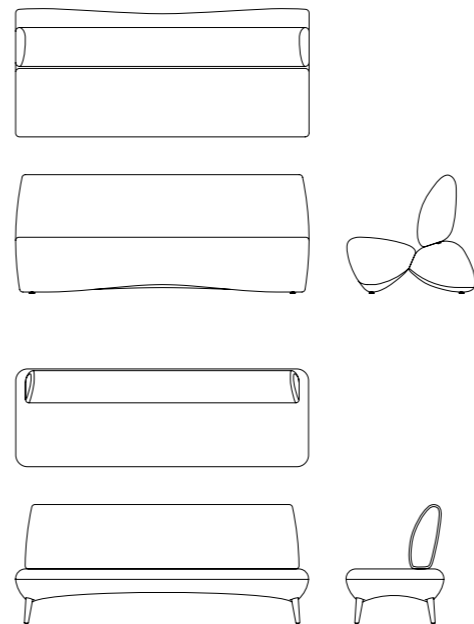

Color



ANSI/
BIFMA
X5.1





Lives Work Lounge Chair

Made in Japan

Today's office chairs demand more than functionality. Relaxed, residential-feel spaces create work environments where workers express themselves and thrive.

Lives Work Lounge bring a casual look to the office and are equipped with the state of the art features that employees have come to expect.

Color



Product Info.



ANSI/
BIFMA
X5.1



Lives Pouf

Made in Japan

Lives Pouf is designed to encourage creative thinking and to support informal ways of working and collaboration in the shared areas of the workplace – such as cafes and touch down points, break-out spaces, co-working environments. Its softness and warmth allow you to create a place to repose within the information storm of our times.

Color



Product Info.





Alt Living

Made in Thailand

For workers, office comfort is a major factor that can influence the outcome of new business ideas and various projects. Alt Living is a sofa system that brings "living room comfort" to the current office. You can create a space where you can work more happily.

Color



Product Info.



drape

Made in Thailand

drape is a minimal-sized pod with sound-absorbing capability. It takes up as little as four carpet tiles to build and transform open offices into a hub of concentration. The outer side of the two-toned panels are colored with brighter hues to uplift the office, while the inside panels are covered with a calming gray tone.

Color

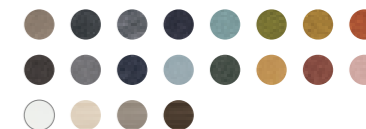

Product Info.



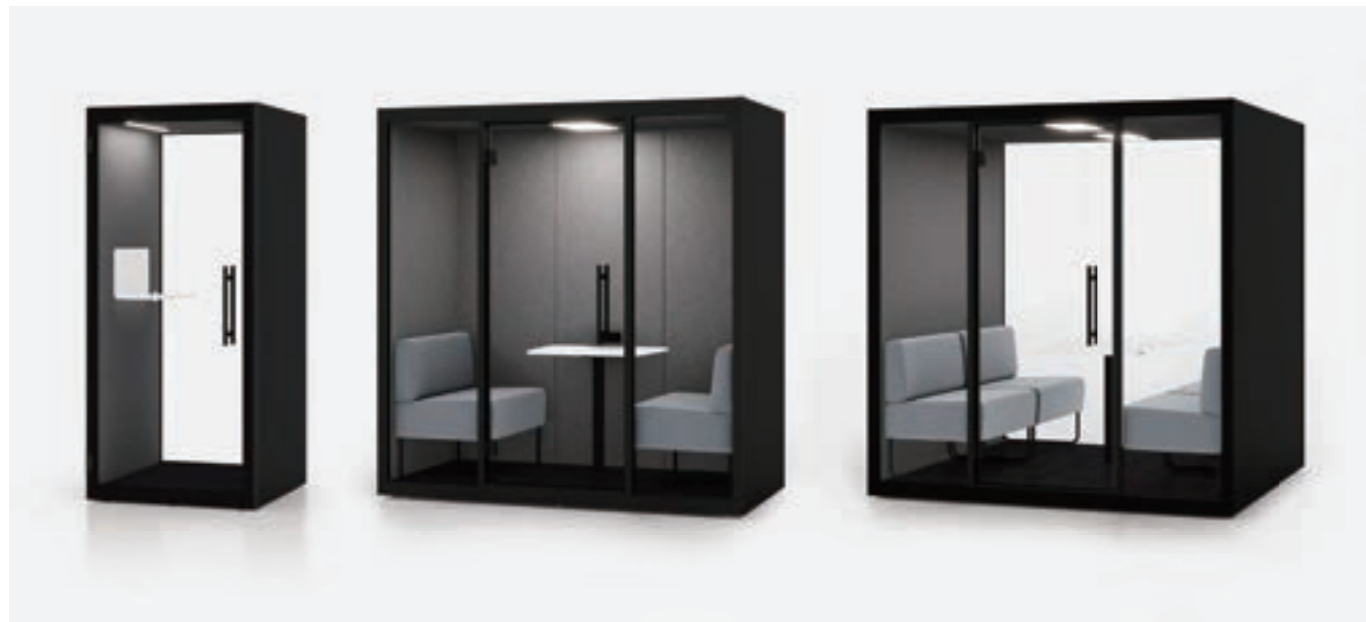

CHATBOX BY SILEN

Made in Republic of Estonia

Every open space deserves a Chatbox for deep work, private calls or a creative session. Increase your productivity by 25%. With over a decade of experience, we ensure superior soundproofing to increase your productivity.

Product Info.

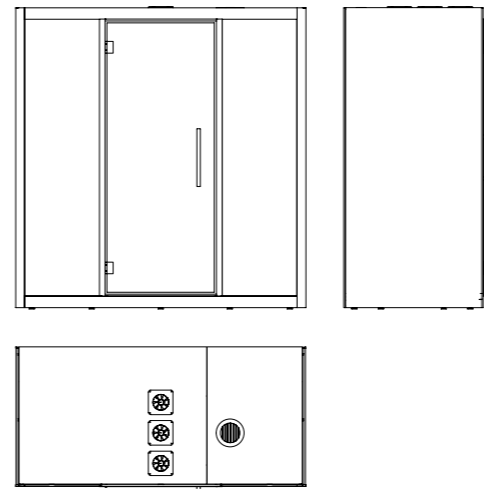

Color





Lives Shelf

Made in Thailand

A shelf with a wide range of usability and configuration, extending the versatility of a display shelf. By reconsidering the structure of the frame and shelf board, it has evolved into a minimalistic design. Not only can it partition the space, but it also can allow or block the visual field with a combination of panels.

Color



Product Info.



SPRINT

Made in Japan

Don't just choose a space that matches your working style - create it. In conventional offices, workers all use the same meeting rooms. But "workstyle reforms" and working from home policies have significantly transformed the way we work. As workers' values become more diverse, what should the office of the future look like? Okamura believes that workers creating ideas in person through teamwork will define the next era of office work.

Color



Product Info.





Posit-A

Made in Thailand

Posit is a partition system that features beautifully streamlined 40mm width panels that are available in a variation of sizes and colors, which can be easily configured to create an enclosed space in the office. Its clean and simple design blends into any kind of office ambiance at a reasonable price.

Color



Product Info.



GO-DO | WORKPLACE PRODUCTS

Made in Japan

5° GO-DO high-performance acoustic panels were designed by Gensler & Associates International Limited to stylishly improve acoustics in open offices. The neutral colors and subtle geometric extrusions create an exquisite, subtle design accent suitable for any office space. 5° GO-DO comes in three shades of gray with creative and modern designs.

Color



Product Info.



CABINET

- DN Mobile Drawer
- KD Storage System
- Personal Locker
- 6S Light-Duty Shelving

• = Stock in HCMC





DN Mobile Drawer

Made in Thailand | Stock in HCMC

The DN Mobile Drawer Series is an easy way to add extra storage space to your workstation. Just place it under the desk and enjoy the simplicity of organizing your work tools.

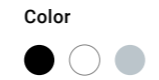

KD Storage System

Made in Thailand

The KD Storage System allows you to save space by selecting storage modules based on your chosen document size. Two size modules are available, alongside five color variations. Create a unique office space that matches your needs. Many accessories support you to create a storage system that adapts to your requirements and optimizes space.





Personal Locker

Made in Thailand

The Personal Locker allows you actively create your space by choosing modules, and accessories.

Color



Product Info.



6S Light-Duty Shelving

Made in Thailand | Stock in HCMC

Easy to assemble, easy to move and ideal for small to medium - item storage. The product is economical and ideal for to medium-weight items. Okamura's original boltless structure enables an easy installation. Extra shelves can be added easily to create a "custom" display.

Color



Product Info.





In offices where workers carry out diverse tasks, it is best if individuals can freely choose the environment optimally suited to their particular needs. Okamura offers proposals that create spaces accommodating of each individual's characteristics and circumstances to maximize their capabilities.



COCORO HO CHI MINH (MANAGEMENT BY STARTS)

Location : Ho Chi Minh City, Vietnam

Industry : Serviced Office

Completion Year : 2024

About the Project :

COCORO Ho Chi Minh is a Japanese serviced office that offers Japanese standard services such as peace of mind, comfort, connection with people, and an eco-friendly environment. Our customers are highly concerned about well-being and sustainability, and we provide Okamura products known for their ergonomic design and sustainability features. One of the chairs we offer is upholstered with "Re:net" a fabric made from used fishing nets.

Products :





KEYENCE VIETNAM

Location : Hanoi, Vietnam

Industry : Electronics

Completion Year : 2023

Design : T.S.I Vietnam Co., Ltd

About the Project :

Keyence supplies sensors, measuring systems, laser marking machines, microscopes, and machine vision systems worldwide, they lead the way in factory automation. Red and black are the corporate color that they cherish it. Our products give essence to their logic and support their workstyle.

Products :



Contessa II Sylphy Plimode Repairou 81T2



C.P. SEED

Location : Dong Nai City, Vietnam

Industry : Agriculture, Financial

Completion Year : 2023

About the Project :

C.P. (Charoen Pokphand) is a multinational corporation and one of Thailand's strongest group in the fields of industry, agriculture and finance. In the field of agriculture, C.P Group is the largest corporation in Thailand and C.P. Products are popular all over the country and around the world.

Products :



Oree Contessa II Portone Smart

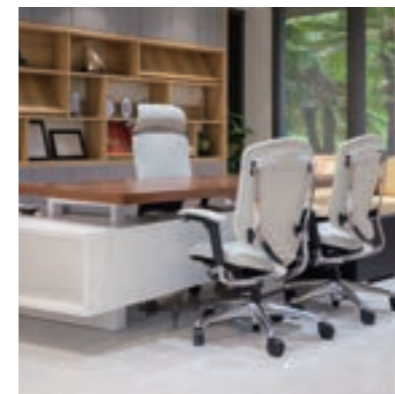



MATTEL OFFICES

Location : Warsaw, Poland

Industry : Entertainment

Completion Year : 2024

About the Project :

Project was run by BitCreative architects. The most challenging was to find conference chairs which will be corresponding in colors to the „Barbie” and „Fisher-Price” brands - the most representative for Mattel.

The customer’s expectations were to find comfortable chairs, which will be consistent with the branding colors but will not dominate in the conference rooms.

Products :



Plimode



LAWSON (CHINA) HOLDINGS CO.,LTD

Location : Shanghai, China

Industry : Retail

Completion Year : 2022

About the Project :

The office renovation project aims to accommodate more staff and a new work style. The new office has a free-address system, exposed ceilings, and indirect lighting to create a brighter and open environment. Curved lines and the color blue are used as interior accents to foster individuality and creativity.

Products :



Contessa II



Portone



Plimode Light

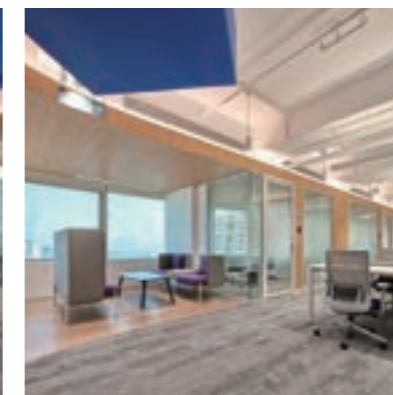
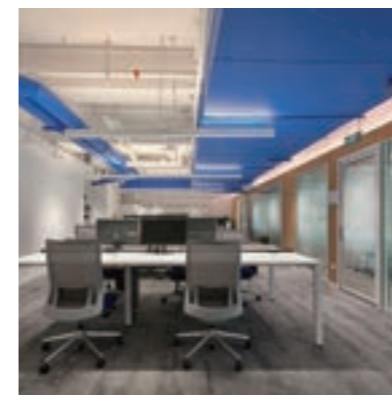



PANASONIC SOLUTIONS (THAILAND HEAD OFFICE)

Location : Bangkok, Thailand

Industry : Manufacturer

Completion Year : 2022

About the Project :

This project aim to integrate each Panasonic Group companies in Thailand into one office. The office has a free space in the center to encourage the interaction of the staff from each group company, provide a comfortable workplace for workers.

Products :



Manifold-A



Rin



Personal Locker



Drape



MITSUBISHI CORPORATION (JAKARTA REPRESENTATIVE OFFICE)

Location : Jakarta, Indonesia

Industry : Trading

Completion Year : 2022

About the Project :

Right sizing project influenced by covid 19. In order to adjust new normal, communication area and personal online meeting rooms are installed. Uses can feel Indonesian aesthetic because Batik, traditional Indonesian pattern, is used in interior design.

Products :



Nagare



Manifold-A



Precede



Plimode



Contessa II



Sylphy

