

Luce

A Ergonomic Multipurpose Seating

Instructions for Use

Thank you for purchasing Okamura "Luce" product. This guidebook will enable to properly use the "Luce" product. Thoroughly read this guidebook and fully understand its content before using the product. Also, we recommend having this handbook nearby whenever using the product.



okamura

Safety Instructions (Make sure to follow these instructions)

⚠ Caution Indicates that improper handling may cause injury or property damage.

⚠ Caution

Avoid handling the product roughly or using it for applications other than those specified.

- Do not place items on top of it and use it as a flatcar. It could overturn, leading to an accident, or the items could fall off it.



- Do not stand on the chair or sit on the anterior portion of the seat or the armrests. This could cause the chair to overturn and lead to injuries.



- Do not sit on any part of the product other than the seat surface.

Take heed of the following items in order to prevent damage or collapsing of the product.

- Do not use the product if you have discovered any abnormalities with it. Doing so could cause the product to collapse and lead to injuries.
- If the product has become unsteady due to loosening of the bolts or screws, retighten them.
- Do not use the product if any parts are separated from it.

Do not put your fingers or hands into the spaces or moving parts of the product. This could lead to injuries.

- Take care to avoid inserting your hands or fingers into the spaces of the back and seat joint.

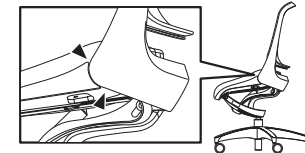

- Take care to avoid inserting your hands or fingers into the spaces of the seat back movable reclining part.

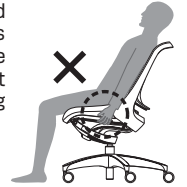

Do not disassemble or repair the product.

- The parts indicated by arrows are filled with pressurized gas. If any abnormalities are discovered, contact our company's sales liaison. Attempts by customers to disassemble or repair the abnormalities can be dangerous.

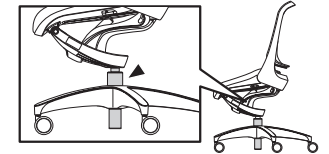

- Do not use if the bolts or screws are loose. Doing so could cause the product to collapse and lead to injuries.

Do not attempt to restructure the product.

- Restructuring by the customer could lead to product malfunction. Also, our company is not responsible for any problems arising from such actions by the customer.
- If restructuring is necessary, contact our company's sales liaison in advance.

About the P tile floor

- Nylon casters are too slippery to use for the tile floor, and could lead to falls and accidents. Use urethane casters instead. Nylon casters are appropriate for floors covered with carpets, rugs, and the like.

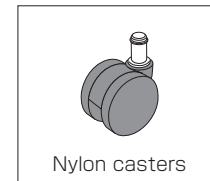

Nylon casters

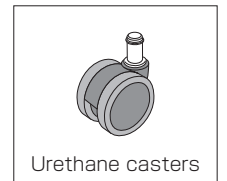

Urethane casters

Installation Instructions

We are not responsible for any malfunction resulted from failure to observe the following precautions.

Use the product indoors.

- Do not use outdoors or places with water, as exposure to moisture could result in problems such as warping or the growth of mold.

Avoid placing the product in places exposed to high temperatures, humidity, or exceptional dryness as this can result in warping, color changes, or the growth of mold.

Avoid placing the product where it will be directly exposed to heat or moving air such as by stoves, air conditioners, or the like as this could result in warping or color changes.

Avoid keeping the product in direct sunlight as this could result in warping or fading of colors due to exposure to the sun.

- Always use curtains, blinds, or the like to protect the product from direct sunlight when installing it next to windows or the like.

Install the product so that its level surface is maintained.

- Maintain the level surface of the main unit when installing the product. If the product is installed without its level surface maintained, the main unit may become skewed, resulting in malfunction of moving parts.

Appropriate ventilation measures

- Many chemical substances will be released by the product when it is first purchased. Sufficiently ventilate or expose the product to moving air for some time after purchasing it.
- Do not completely close windows when using the product in rooms with conspicuously high temperatures/humidity (the benchmarks for these are temperatures in excess of 28°C and relative humidity in excess of 50%).

Names of Parts

Type with armrest

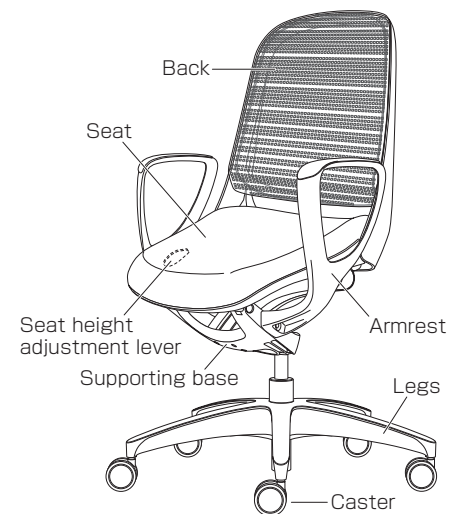

Type with no armrest

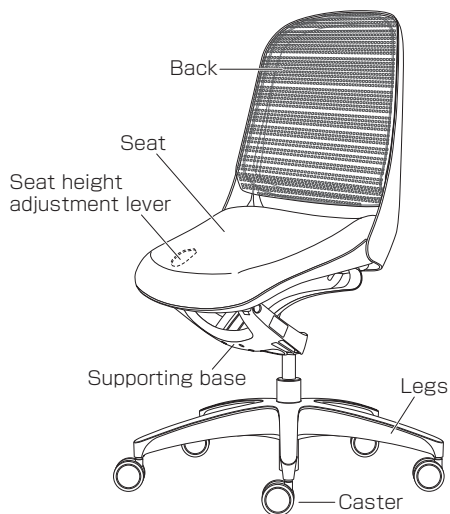

Operation guide

Seat height adjustment

If while sitting the lever located in the seat rear left side is pulled upward, the seat will be lowered, and can be stopped at the desired position by releasing the lever. When raising the seat, keep your hips suspended above the seat surface while pulling the lever upward.

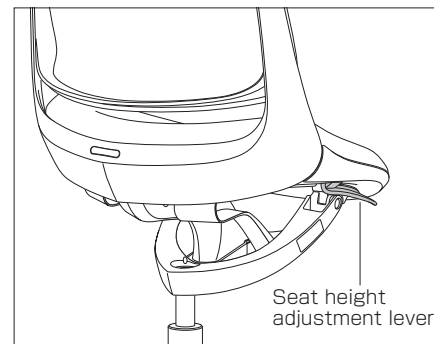

Reclining mechanism

When you sit down, the seat will sink 15°. The back can recline with a 15° range.

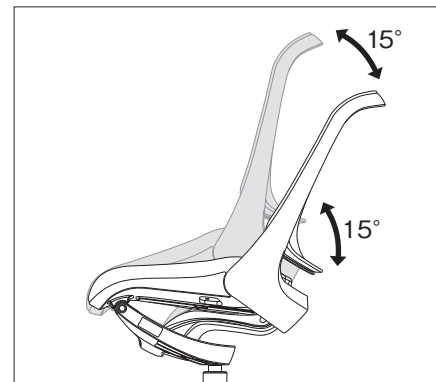

Caution

Do not forcefully lean on the back at greater than 15°. This could lead to collapse or damage of the chair.

FAQ

Question	Check	Correspondence
Seat cannot be lifted up.	Are you fully sitting when adjusting seat height ?	Adjust seat height without any load on the seat.
	Is seat height in the highest position ?	Seat will not rise over the highest position.
Seat cannot be lowered.	Are you sitting on the front side of seat?	Please sit on center of the seat while adjustment.
	Is seat height in the lowest position ?	The seat will not lower beyond the lowest position.
Casters do not move smoothly.	Are you using rubber casters on rug or carpets ?	Use urethane casters on rugs or carpets.
	Is it tangled with lint or wool ?	Remove foreign object or replace the caster.
Casters are slipping.	Are you using urethane casters on hard floor such as plastic tile floor ?	Use rubber casters.
Chair makes noise.		Please contact our official dealer.

Instructions to Extend the Life of Product

We are not responsible for any malfunction resulted from failure to observe the following precautions.

Instructions for Use and Maintenance

- If the product has become unsteady due to loosening of the bolts or screws during use, retighten them immediately.
- Do not use in places exposed to vapors. This could cause rusting.
- If water has spilled onto the surface, wipe it away with a dry, soft cloth.
- This instruction manual is very important, so store it in an easily accessible location.
- Frequent maintenance of the product during its use is the key to making it last a long time. Immediately request inspections and repairs (fee required) from our company when the warranty period has expired.

Care

Regular care.

- For regular care wipe the chair with a soft, dry cloth.

Care when the product is very dirty.

- Dampen a soft cloth with a diluted (1~3%) neutral detergent solution, thoroughly wring out the cloth, and then wipe away the dirt. Afterwards, dry-wipe the product with a dry, soft cloth so that no detergent is left behind.
- ※ About cloth covered parts and materials;
After lightly beating the surface, remove dust with a brush or vacuum cleaner.

Care precautions.

- Use commercial cleaners and the like after confirming that there has been no discoloration or the like to its inconspicuous parts.
- ※ About mesh materials and cushion parts
- After dusting off the mesh parts with your hands, remove the dust using an electronic vacuum cleaner. Also, because the cushion parts cannot be cleaned, we recommend exchanging for new cushion parts if they have become conspicuously dirty.

Materials

Part		Main materials
Structural parts and materials	Back frame	Polyamide resin >PA<
	Seat shell	Recycled polyamide resin >PA<
	Seat inner shell	Recycled polypropylene resin >PP<
	Legs	Aluminum die cast >ADC<
	Supporting base	Aluminum die cast >ADC<
	Armrest	Polyamide resin >PA<
Surface materials	Back mesh	100% polyester
	Seat cloth	100% polyester (includes 62% recycled PET)
	Armrest pad	Polyurethane resin >TPU<
Cushion materials	Seat	Mold urethane

※>○○< indicates the materials of the parts. This information is useful when recycling.

※Please understand that product specifications might change without prior notification when improvements are made to the product.

Product code label

This product is affixed with a product code label inscribed with the product code and the like. Check the contents of the label when making inquiries or reordering the same kind of product.

okamura	
Product	○○○○
Model Code	○○○○ ○○○
Lot No.	○○○○○○

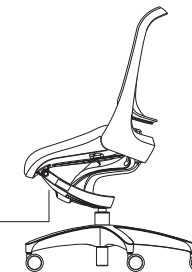

okamura

OKAMURA CORPORATION

INTERNATIONAL SALES & MARKETING DIVISION
2-14-27, Akasaka, Minato-ku, Tokyo 107-0052, JAPAN
Tel : +81-3-5561-4085 Fax : +81-3-5561-4086
<http://www.okamura.jp>

000000
2011-05