

**OKAMURA**

OKAMURA CORPORATION

INTERNATIONAL SALES & MARKETING DIVISION  
2-14-27, Akasaka, Minato-ku, Tokyo 107-0052, JAPAN  
Tel : +81-3-5561-4085 Fax : +81-3-5561-4086  
<http://www.okamura.jp/>

G1A743  
2018-05



# *Sabrina*

## *Smart Operation*

Office Seating

Instructions for Use  
Gebrauchsanleitung  
Mode d'emploi  
Instrucciones de uso  
Istruzioni per l'uso  
Gebruiksaanwijzing

**OKAMURA**

## Safety Instruction (Keep this operation manual)

### Symbol indications

Various symbol marks are used in this instruction manual and displayed on the products to show correct and safe usage and to avoid harm to you and others or damage to property. Please understand those before reading the main text of this manual.



User must follow this instruction to prevent from accidents and injuries, or damages to their property.

### Caution

#### Do not handle roughly, or use improperly.

- Do not use as a carrier.
- Do not stand on the chair or sit on the front side of seat or armrest.



#### Do not disassemble or repair on your own. Please contact our official dealers when needed.



#### No remodeling. Okamura will have no responsibility for any disadvantage caused by remodeling.

#### Gas lift replacement and handling should only be carried out by the trained personnel.

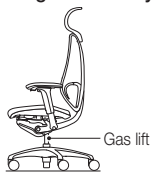

#### Be careful not to put fingers, hands or clothes caught in gaps between moving parts or under armpad when adjusting the armrest position.



#### Casters

- For hard floors made of ceramic, stone, tile or wood, use soft.
- For soft floors using carpet or rug, use hard casters.
- Color identification of wheel --- Hard caster : Black, Soft caster : Gray.



#### Adjustable armrests

Be careful not to get your fingers, hand or clothes caught in the gaps between the moving parts or the back of the pad when adjusting the position of the armrests. Also, make sure that the armrests are fixed tightly before use.

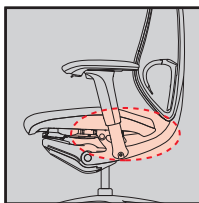

## Installation

Please follow instructions below. Failure may cause serious damage to the product.

Indoor use only.



No outdoor or waterfront use.



Avoid direct sunlight.



When placing alongside windows, use curtain or blind to avoid from direct sunlight.



Avoid high temperature, high humidity, or extraordinary aridity.

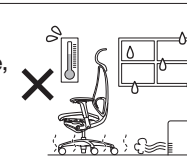

Do not place product under heater or air-conditioner exhausting high temperature air.



Do not place on uneven floor.



## For maintenance

Regular maintenance is tips for long-life use.

If found unstable due to loose bolts and screws, tighten them.

For daily care, use a well-wrung soft cloth.

For stained part, use neutral detergent (1-3%) and completely remove detergent with dry soft cloth.



For mesh and cushion parts, remove dust by tapping the cloth surface with brush or using vacuum cleaner.

Cushion part cannot be dry-cleaned so that replacing is recommended if exceptionally dirty.

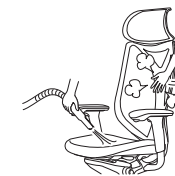

## Part names



## Adjustable range

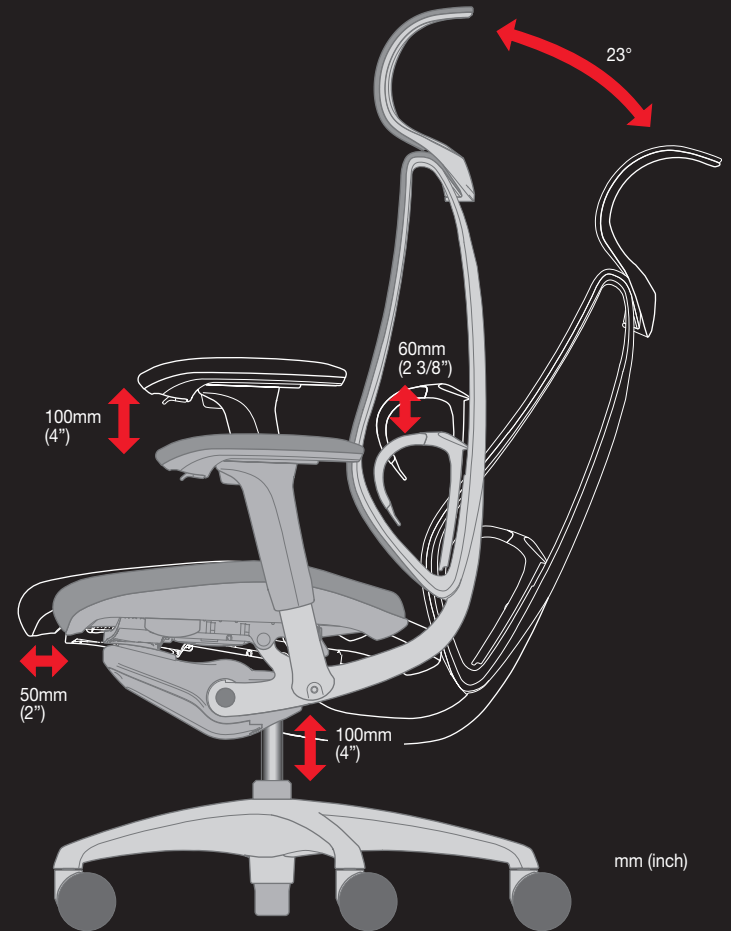

## Operation guide

### Seat height adjustment

Adjust the seat height using the Seat height lever located at the front of the right armrest. The seat will lower if you lift the lever while seated, and it will stop at any position you release the lever at. The seat will be raised if you lift the lever while not seated on the seat.

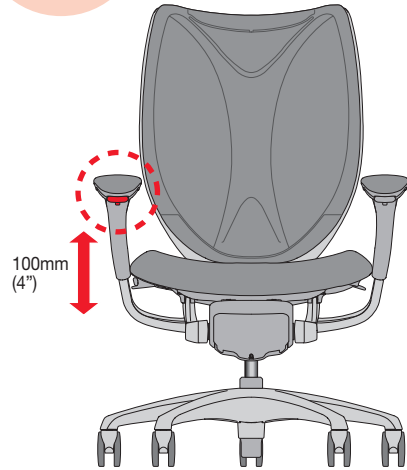
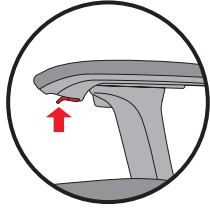

mm (inch)

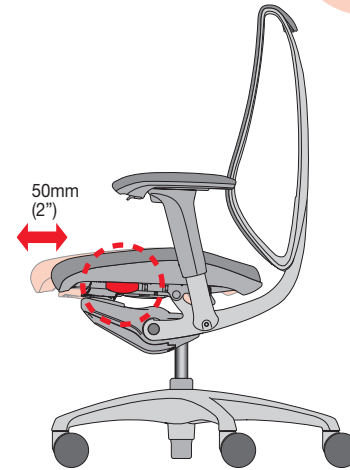
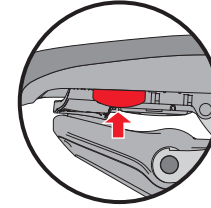

mm (inch)



### Seat depth adjustment

Adjust the seat depth by sliding the seat forward or back within a range of 50 mm (2") using the Seat slide lever on the bottom left of the seat. This allows for maintaining an appropriate distance between the back and the front edge of the seat, reducing pressure on the back of the knees and providing reliable support for the lower back.

## Operation guide

### Reclining adjustment

Adjust the back recline by using the Reclining lock/release lever located at the front of the left arm. Click the lever in the tilted position to lock reclining. To release the lock, click the lever once again. When releasing the lock, slightly lean against the back of the seat.

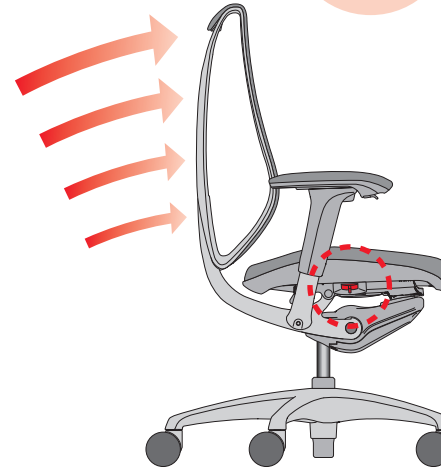
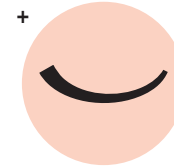
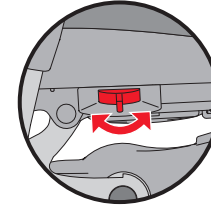
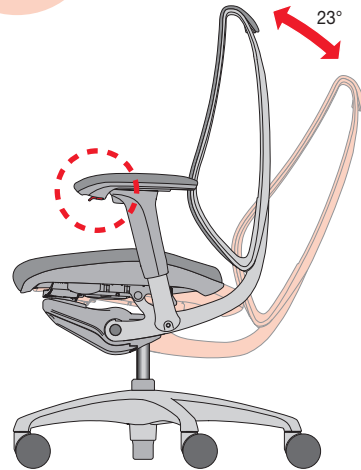
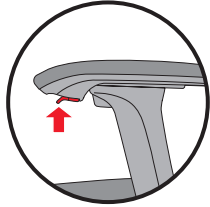

### Reclining resistance adjustment

Adjust the reclining resistance by using the Reclining tension adjustment lever on the bottom right of the seat. The resistance to the back of the seat will be increased if you slide the lever back (+), and the resistance will be decreased if you slide the lever forward (-). Adjust it so that it is comfortable.

#### Note

To operate, verify that the reclining lock is released, and move your back away from the seat back before using the Reclining tension adjustment lever. The lever will not move when reclining is locked.



## Operation guide

### Adjustable arm height adjustment

Release the height lock using the height adjustment button on the bottom of the arm pad. The arm height can be adjusted up and down within a range of 100 mm (4") by pushing and holding the button. Lock again by releasing the button. Holding the arm pads and rotating them left and right allows for adjustment of their angles (20° inside, 10° outside). They can also be adjusted forward and back within a range of 40 mm (1 1/2"), or left and right within a range of 25mm (1").

#### Note

Before using this product, make sure that the position is securely locked after making the adjustment.

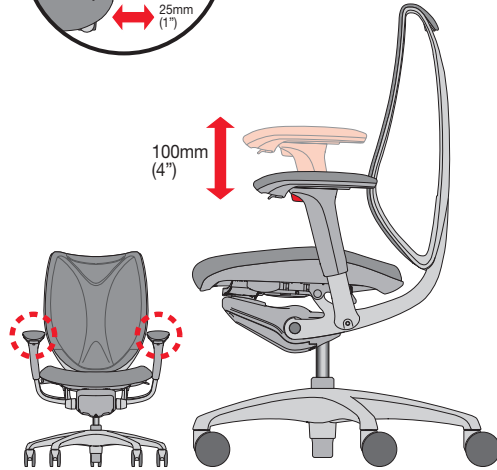
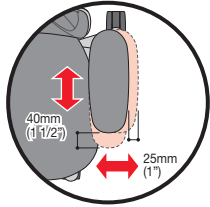
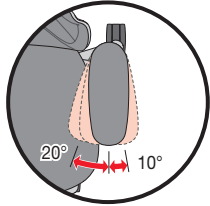
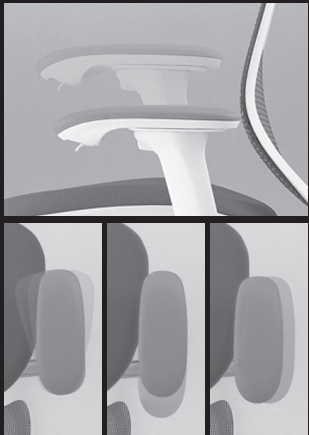

mm (inch)

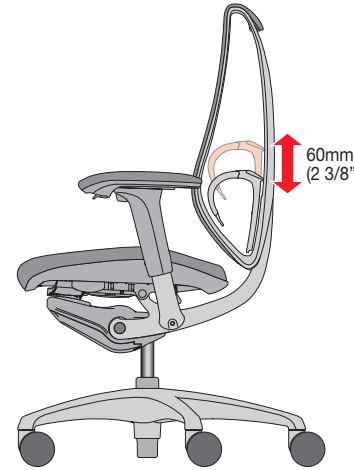
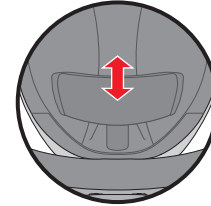

mm (inch)

### Adjusting Lumbar support (option)

Move the Lumbar support on the back side of the seat back, up and down directly. The Lumbar support can be moved up and down within a range of 60 mm (2 3/8").



## Operation guide for options

### Headrest (option) attachment and replacement

- (1) Insert the grooves of the Headrest into the backside of the seat back.
  - (2) Secure it with a fastening bolt.
- \* Make sure that the Headrest is secured completely before using.

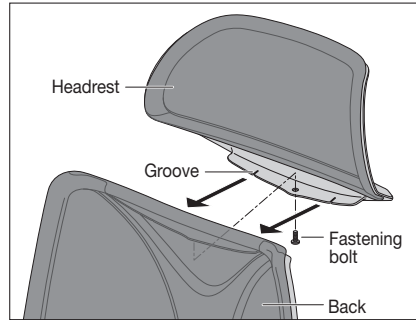

### Hanger (option) attachment and replacement methods

- (1) Insert the tabs of the Hanger into the backside of the seat back.
  - (2) Secure it with a fastening bolt.
- \* Make sure that the hanger is secured completely before using.

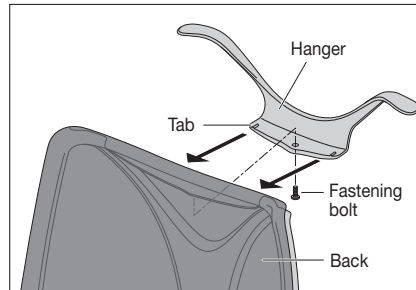

### Attaching and Replacing a Headrest (option) and Hanger (option)

The Headrest and Hanger can be attached at the same time as shown in the illustration. Attach the Headrest first, and then attach the Hanger.

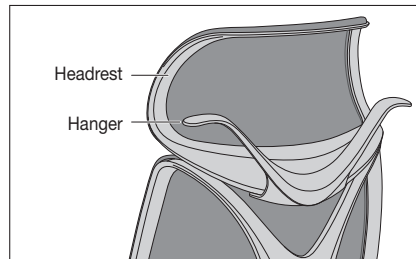

## Materials

Part		Materials	
Structural parts	Back	Body	Glass-reinforced polyamide >PA-GF<
		Frame	Die-cast aluminum >ADC<
	Seat	Outer shell	Glass-reinforced polyamide >PA-GF<
		Inner shell	Recycled polypropylene resin >PP<
		Frame	Glass-reinforced polyamide >PA-GF<
	Support base		Die-cast aluminum >ADC< Steel
	Adjustable arm	Polyurethane >TPU<	
		Glass-reinforced polyamide >PA-GF<	
		Die-cast aluminum >ADC<	
	Legs		Die-cast aluminum >ADC<
Options	Lumbar support	Polyamide >PA<	
		Polyurethane >TPU<	
	Headrest	Glass-reinforced polyamide >PA-GF<	
Hanger	Glass-reinforced polyamide >PA-GF<		
Covering material	Mesh	Polyester	
	Cloth	Polyester	
Cushion material	Seat	Polyurethane >PUR<	

\* > XX < indicates the materials of the parts. This information is useful for recycling.

\* Please understand that product specifications might change without prior notification due to improvements made to the product.

## Troubleshooting

Problem	Check	Solution	Page
The seat does not rise.	Are you sitting on the seat when adjusting the seat height?	Adjust the seat height while not seated on the seat.	5
	Is the seat height in its highest position?	The seat cannot rise beyond the highest position.	5
The seat does not lower.	Are you sitting on the front edge of the seat?	Sit in the center of the seat while adjusting.	5
	Is the seat height in the lowest position?	The seat cannot lower beyond the lowest position.	5
The seat slide lever does not work.	Are you sitting on the seat when adjusting the seat depth?	Adjust the seat depth while not seated on the seat.	6
The seat back does not recline.	The lever at the front of the left arm is locked.	Lift the lever to release the lock, and then lean against the seat back.	7
	The reclining tension adjustment lever is set to the strong (back) position.	Turn the reclining tension adjustment lever to the weak (front) position.	8
Casters do not move smoothly.	Are they tangled with lint or wool?	Remove lint or wool or replace the casters.	*
Casters are slippery.	Are you using urethane casters on hard floors such as a plastic tile floor?	Use rubber casters.	*
Chair makes noise.	-	Visit a retail shop or the nearest branch.	*

\* Please contact an official dealer.