

Sabrina

Spec Guide

Issued August 2019

[BIFMA (mm) Standard]



okamura

Sabrina Standard

Color options for body



Black



White

Armrest types



Adjustable Armrest

[Options]

C8529A-G□□□

G721: Black, GB03: White

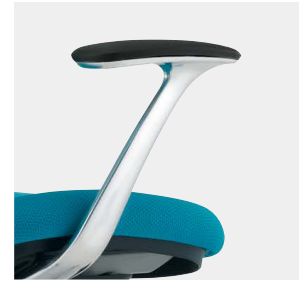

Fixed Armrest

[Options]

C8524A-G□□□

G721: Black, GB03: White

Options



Fixed Headrest

C8501Z-FS□□

(Black Body)

C8501X-FS□□

(White body)



Hanger

C8926W-G□□□

G721: Black, GB03: White

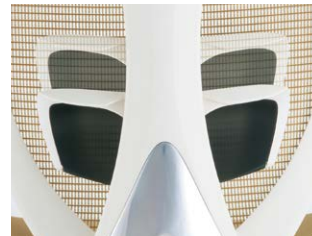

Adjustable Lumbar support

C8518W-G□□□

G721: Black, GB03: White

Product Code

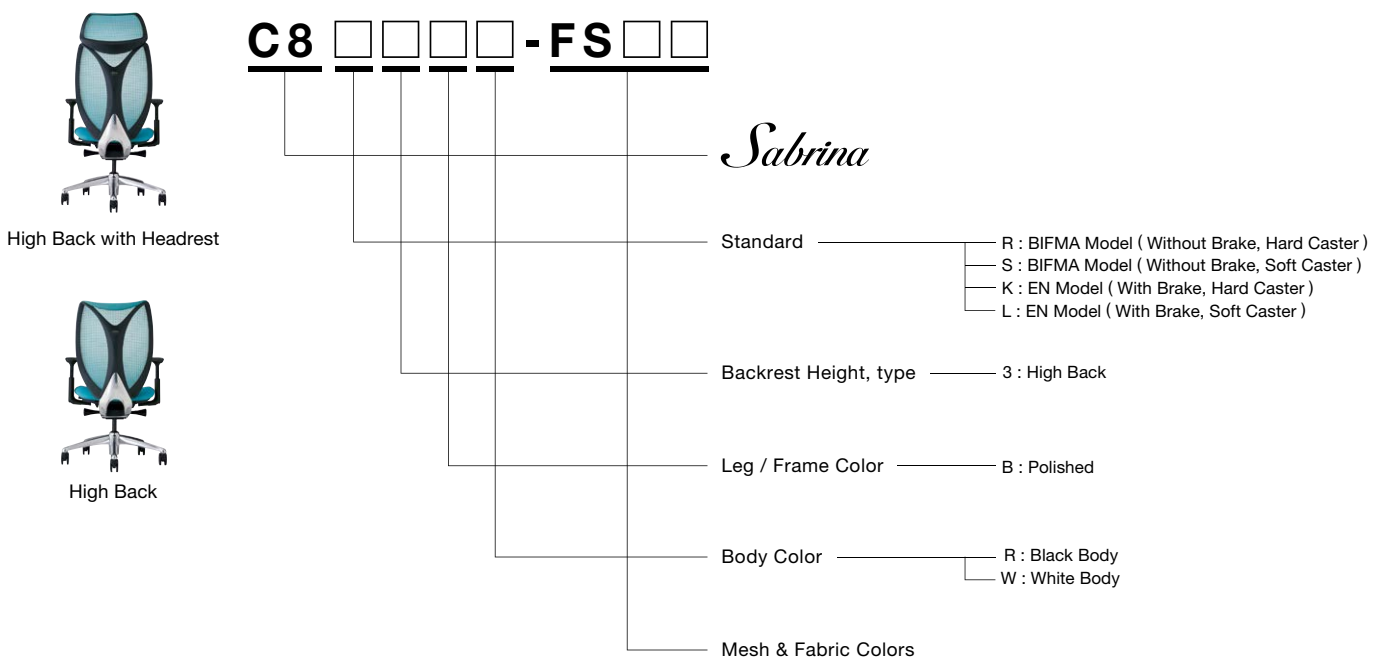

Sabrina Smart Operation

Color options for body



Black



White

Options



Fixed Headrest

C8501Z-FS□□
(Black Body)

C8501X-FS□□
(White body)



Hanger

C8926W-G□□□
G721: Black, GB03: White



Adjustable Lumbar support

C8518W-G□□□□
G721: Black, GB03: White

Product Code



C8 □ □ □ □ **-FS** □ □

Sabrina

- Standard
 - H : BIFMA Model (Without Brake, Hard Caster)
 - J : BIFMA Model (Without Brake, Soft Caster)
 - E : EN Model (With Brake, Hard Caster)
 - F : EN Model (With Brake, Soft Caster)
- Backrest Height, type
 - 3 : High Back
- Leg / Frame Color
 - B : Polished
- Body Color
 - R : Black Body
 - W : White Body
- Mesh & Fabric Colors

Color Variations

Mesh Back and Cushion Seat

Back							
Seat							
	FSY1 Black	FSZ3 Light Gray	FSY2 White	FSZ4 Dark Blue	FSY3 Medium Blue	FSY4 Aqua Blue	FSZ6 Blue Green
Back							
Seat							
	FSZ5 Dark Green	FSY5 Lime Green	FSY6 Mango Yellow	FSZ8 Orange	FSY9 Red	FSY8 Dark Brown	FSY7 Beige

Fixed Headrest

FSP1 Black	FSR3 Light Gray	FSP2 White	FSR4 Dark Blue	FSP3 Medium Blue	FSP4 Aqua Blue	FSR6 Blue Green
FSR5 Dark Green	FSP5 Lime Green	FSP6 Mango Yellow	FSR8 Orange	FSP9 Red	FSP8 Dark Brown	FSP7 Beige

Color Variations kvadrat (Special Fabric)

※ Only Sabrina Standard

Steelcut Trio

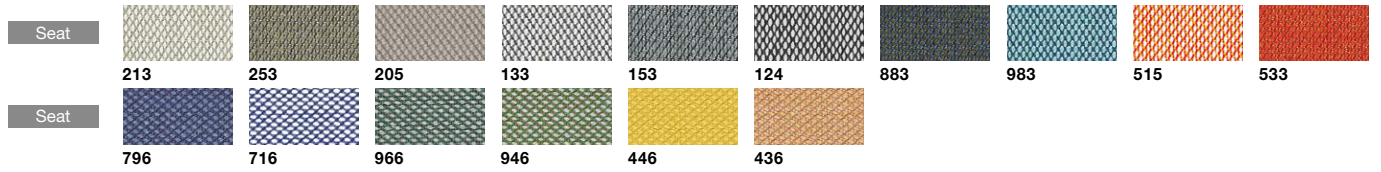

Remix

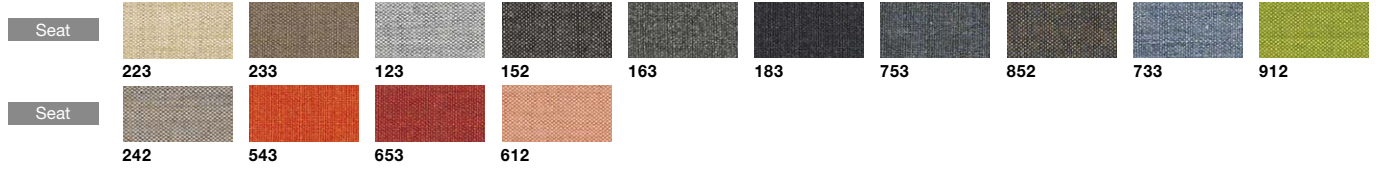

Umami3



Divina MD



Divina



Revive1



Recheck

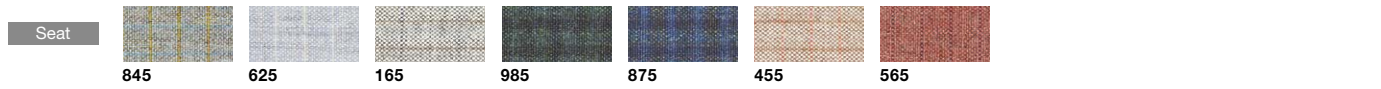

Color Variations Japan-made (Special Fabric)

※ Only Sabrina Standard

TRAD

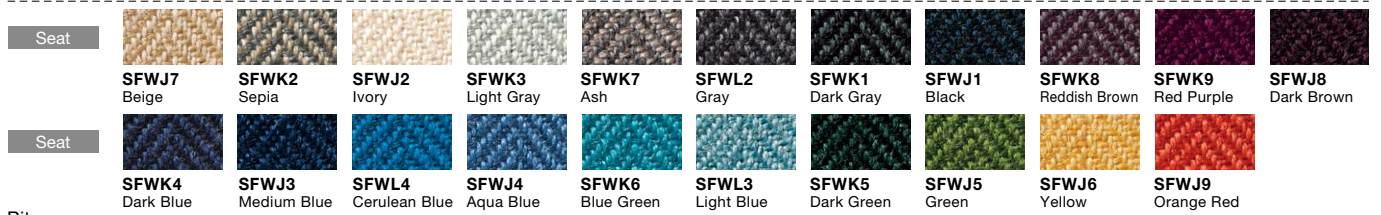

Bit



Bark

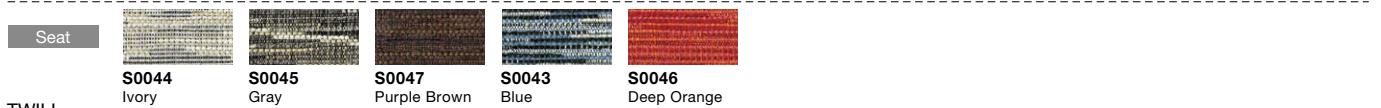

TWILL



Interlock



Sabrina Standard

Chair Type	Adjustable Armrest	Fixed Armrest
High Back with Headrest	<p>650(Arm) 520(Seat) 495(Back) 570~620 400~450 585~815 435~565 1185~1315 φ740 (leg outside diameter) with Hanger and Lumber Support</p>	<p>650(Arm) 520(Seat) 495(Back) 570~620 400~450 636~766 435~565 1185~1315 φ740 (leg outside diameter) with Hanger and Lumber Support</p>
High Back	<p>650(Arm) 520(Seat) 495(Back) 565~615 400~450 585~815 435~566 995~1125 φ740 (leg outside diameter)</p>	<p>650(Arm) 520(Seat) 495(Back) 565~615 400~450 636~766 435~565 995~1125 φ740 (leg outside diameter)</p>

Sabrina Smart Operation

Chair Type	
High Back with Headrest	<p>695(Arm) 535(Seat) 495(Back) 570~620 400~450 580~780 440~540 1190~1290 φ700 (leg outside diameter) with Hanger and Lumber Support</p>
High Back	<p>695(Arm) 535(Seat) 495(Back) 565~615 400~450 580~780 440~540 1000~1100 φ700 (leg outside diameter)</p>

OKamura

OKAMURA CORPORATION

International Sales & Marketing Div.

2-14-27, Akasaka, Minato-ku, Tokyo 107-0052, JAPAN

Tel: +81-3-5561-4085 Fax: +81-3-5561-4086

www.okamura.com

The products listed in this catalog are available as of August 2019. Please note that specifications, dimensions, and colors are subject to change without notice. The colors of the actual products may differ somewhat from the colors shown in the catalog, depending on printing conditions.