

Office Seating

Abilis

Instructions for Use



Contents

1. Safety Instructions	1P
Warning	1P
Notes	1P
2. Instructions to Extend the Life of Product	2P
Usage Precautions	2P
3. Parts Name	3P
Swivel Chair	3P
4. How to use the product	4P
Seat Height Adjustment	4P
Seat Depth Adjustment	4P
Reclining Fix/release	5P
Reclining Tension Adjustment	5P
Adjustable Armrest Height Adjustment	6P
Hanger Height Adjustment (Option)	6P
Lumbar Support Height Adjustment (Option)	7P
Headrest Height Adjustment(Option)	7P
5. Daily Care Instructions	8P
Daily care	8P
Regular Maintenance	9P
After-sales maintenance	9P
6. Troubleshooting	10P
7. Specification	11P
Main Materials and Surface Finish	11P

Introduction

Thank you for purchasing Okamura product. Please store purchase history documents, such as a statement of delivery and a receipt in a safe place. In addition, carefully read this Manual before using the product.

Hazard Levels



This Manual and the indications on the products show the degree of harm and damage to help you safely and correctly use the products, preventing you, people nearby, and properties from being damaged.

 WARNING	Improper handling without due attention to this symbol may result in death or serious injury.
--	---

 CAUTION	Improper handling may cause injury or property damage.
--	--

Information on Graphic Symbols

This Manual and the indications on the products use various types of symbols. The symbols mean as shown below.

-  This symbol indicates a warning or caution.
-  This symbol indicates what you must not do.
-  This symbol indicates what you must do.

1. Safety Instructions

Failure to observe the following safety precautions may result in injury. Carefully read the following to understand the properties of this product before use.

WARNING



Do not attempt to disassemble or repair the product on your own as it is dangerous.

- The seat lifting/lowering device (gas spring) is filled with high pressure gas. If you find any abnormalities, contact our dealer or Customer Service without disassembling or repairing by yourself, which is very dangerous.

CAUTION



Observe the following precautions to prevent the product from being damaged to cause you to get injured.

- Do not handle roughly, or use improperly.
- Do not use the product with loose bolts or screws. Failure may cause the main unit to be broken and cause injury.
- Do not disassemble, repair, or remodel the product by the customer.



Observe the following precautions to prevent fall injury.

- Do not use this product as a step stool.
- Do not stand on the seat.



Observe the following precautions to prevent the fingers from being caught and injured.

- Do not put your hands or fingers in the gaps or movable portions.



Implement proper ventilation to reduce the concentration of chemical substances in the room.

- Immediately after the purchase, there are some cases in which chemical substances are emitted a lot. Be sure to implement sufficient ventilation for a while. The product has satisfied the environmental standards. However, some individuals may have hypersensitivity reactions to chemicals depending on their constitution.
- Do not completely close windows when using the product in rooms with conspicuously high temperatures/ humidity (the benchmarks for these are temperatures in excess of 28°C (82.4°F) and relative humidity in excess of 50%).

2. Instructions to Extend the Life of Product

Failure to observe the following handling precautions may result in damage or malfunction due to failure, etc. In that case, Okamura will not take any responsibility or liability for any phenomena caused.

Usage Precautions

Pay attention to the following when installing to prevent deformation, etc.

- Avoid places exposed to direct sunlight. Failure may cause deformation or discoloration. When installing the product near windows, constantly block direct sunlight with curtains, blinds, etc.
- Do not place any heat generating objects such as a stove or kettle. Failure may cause deformation or discoloration.
- Do not use the product outdoors. Failure may cause warping, mold, rust, etc. Make sure to use it indoors.
- Do not use the product in places exposed to water. Failure may cause warping, mold, rust, etc.
- If the room becomes extremely hot and humid (temperature 28°C, relative humidity over 50% as a guide), do not close the windows completely. Failure may cause deformation, discoloration, and/or mold.

Pay attention to the following. Failure may cause distortion of the body and malfunction of the moving parts.

- Be sure to keep the product horizontal.

3. Parts Name

Swivel Chair

[Fixed Armrest Type]

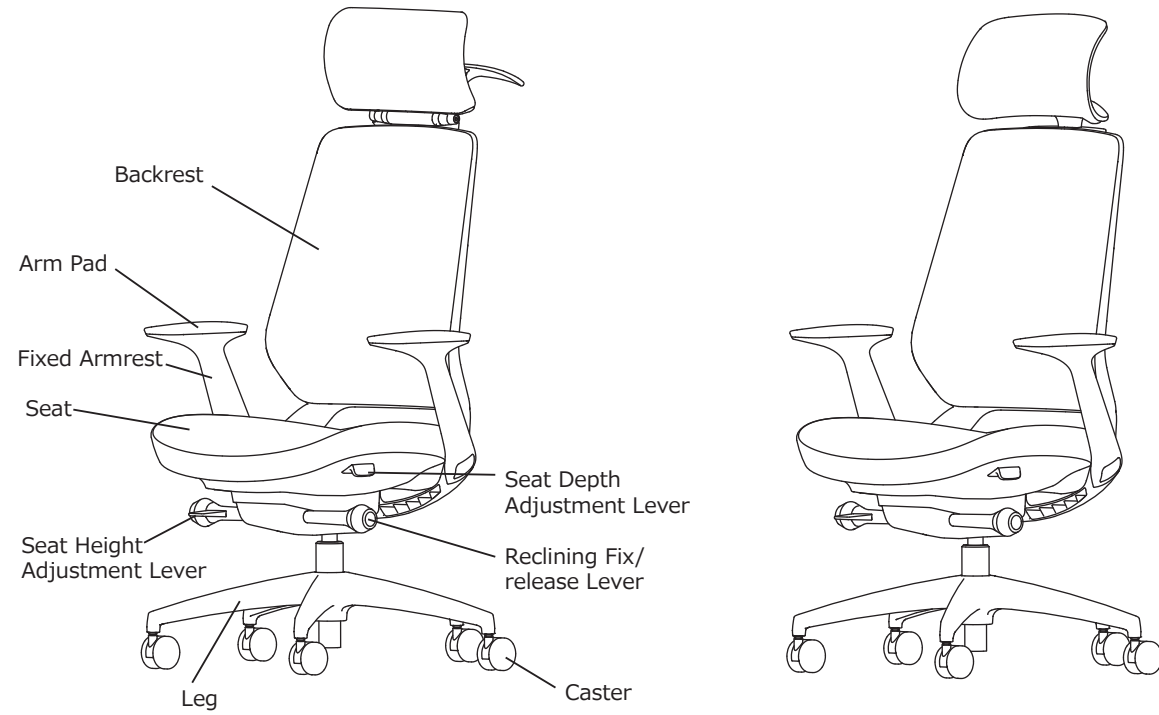

[Adjustable Armrest Type]

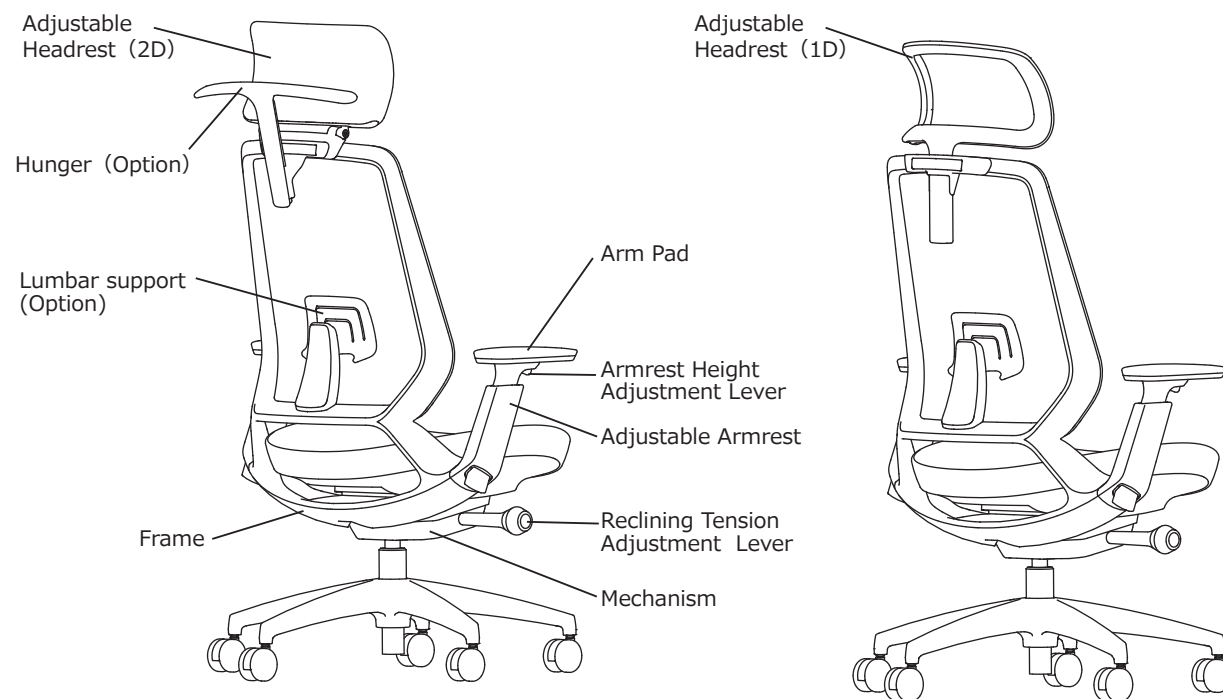

4. How to use the product

Seat Height Adjustment

Adjust seat height using the lever located under the seat's right side (see height adjustment icon). To lower seat, while sitting on it pull the lever up, as shown in [Hand motion]. The seat will descend. Fix seat height by releasing lever when seat is at desired height. To raise the seat, pull the lever up while raising your upper body slightly.

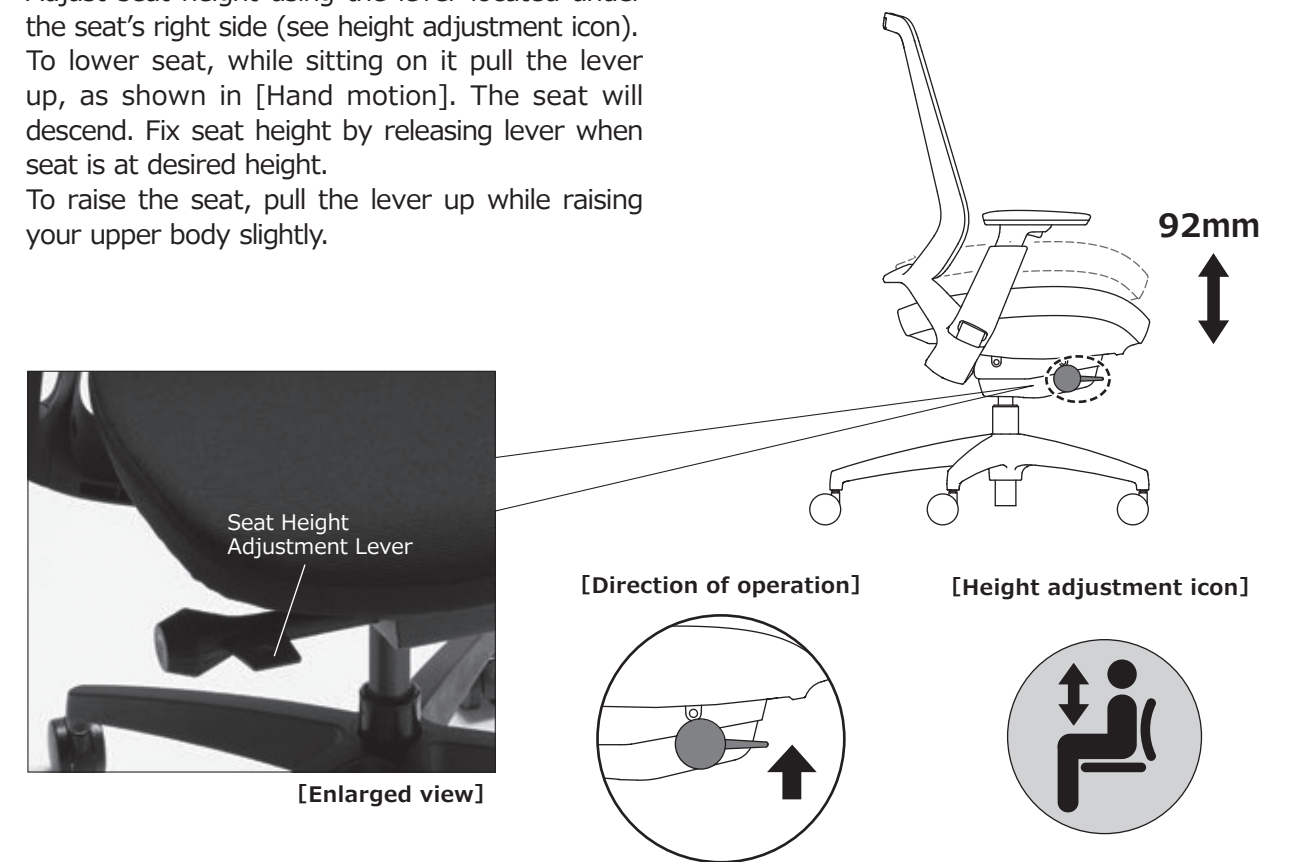

Seat Depth Adjustment

Adjust chair depth using the lever located under the seat's left side (see depth adjustment icon). Use this feature to adjust the distance between the backrest and the chair front to reduce pressure behind your knees and provide robust lumbar support. To adjust seat depth, pull the lever up, as shown in [Hand motion], and slide seat back or forward within adjustment range of 40 mm. Fix seat depth by releasing lever when seat is at desired position.

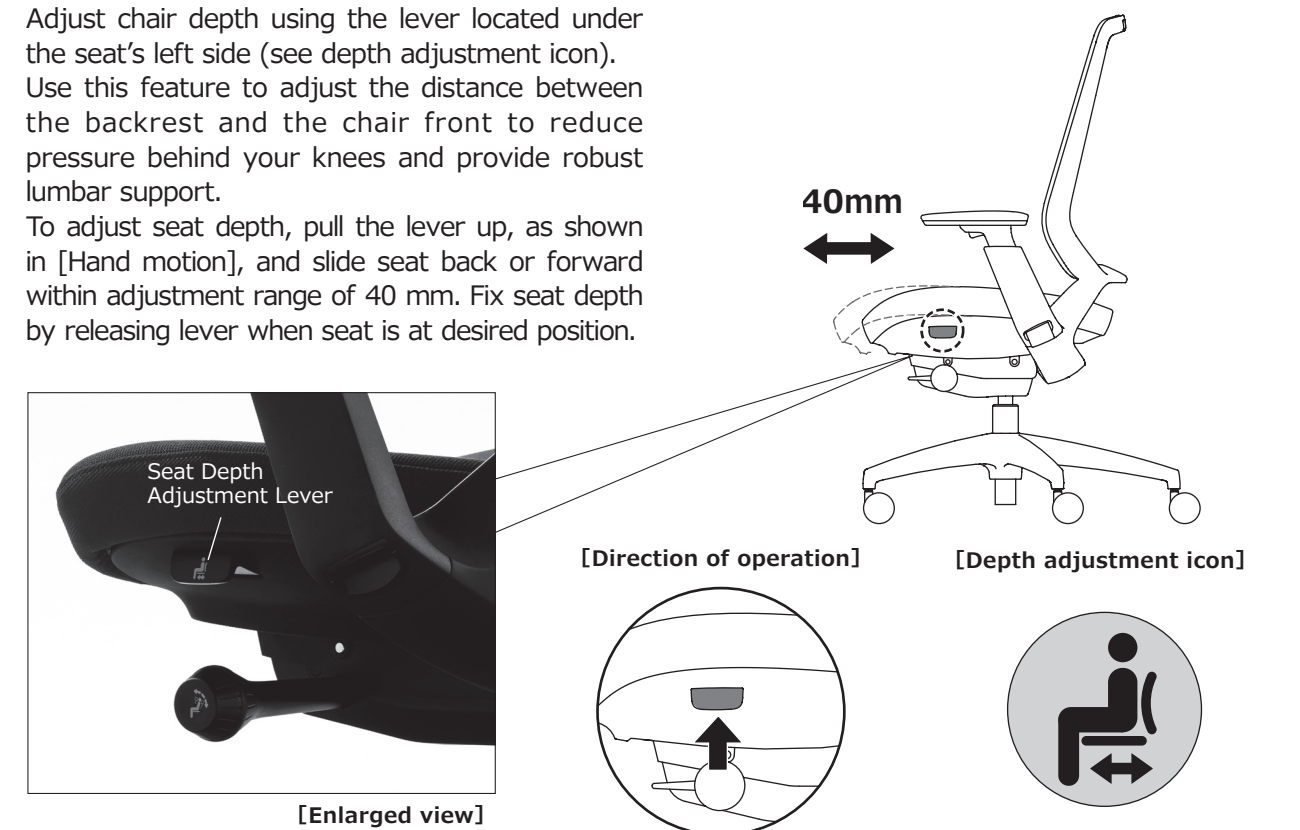

4. How to use the product (continued)

Reclining Fix/release

The seat reclining mechanism is operated by shifting the reclining lock/unlock lever under the seat on the left. Lean against the backrest to tilt it back. At the desired angle, shift the lever once to fix the backrest position.

Shift the lever once again to release the backrest. Lean back slightly against the backrest to position it at the desired recline angle.



[Enlarged view]

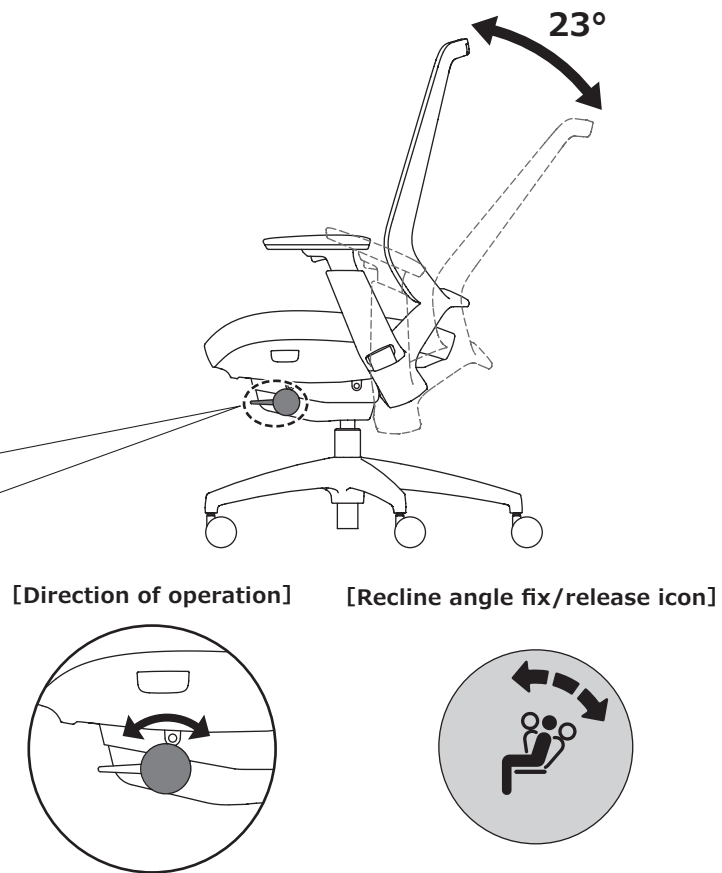

Reclining Tension Adjustment

Use the reclining tension adjustment Lever under the seat on the right to adjust reclining tension. Turn the dial clockwise/counterclockwise to increase/decrease the flex force of the backrest. Adjust reclining tension for your preferred sitting style.



[Enlarged view]

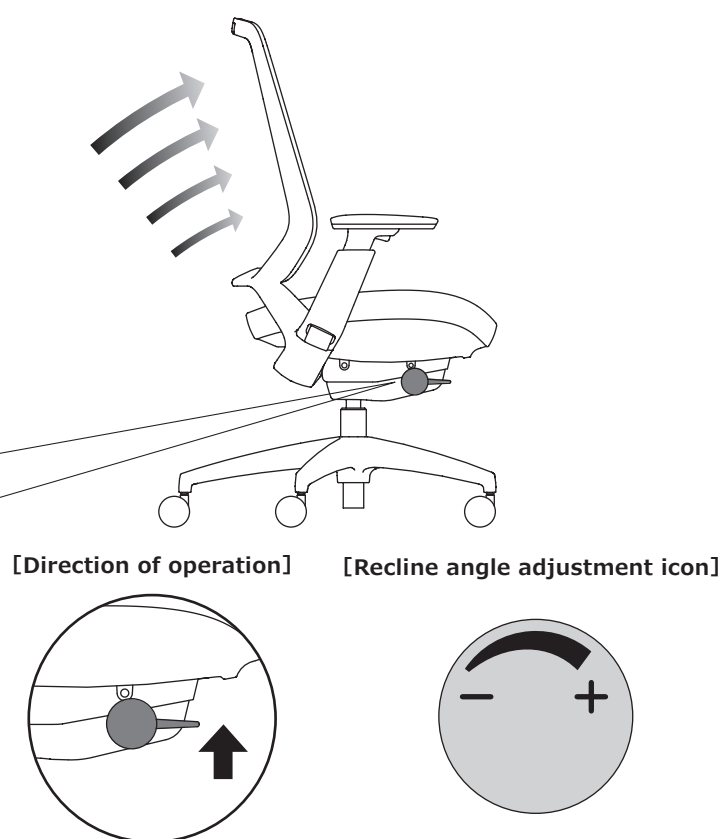

4. How to use the product (continued)

Adjustable Armrest Height Adjustment (Option)

Hold down on height adjustment button under armrest pad to unlock armrest vertical position. Armrest can be adjusted within a vertical range of 100 mm. Fix armrest position by releasing button when armrest is at desired height. Armrests can be rotated left-right within a range of 40°.

Armrest position can be adjusted by sliding forward or back within a range of 50 mm.

Please be careful.

- When changing the adjusting arm position, avoid letting fingers, hands or clothing get caught in any gap between movable parts or under the armrest pad.
- After adjustments, make sure the armrests are securely fixed before using the chair.
- When rotating the armrest, never place your hand or fingers against the sliding part under it. Doing so could cause them to get jammed.

[Direction of operation]

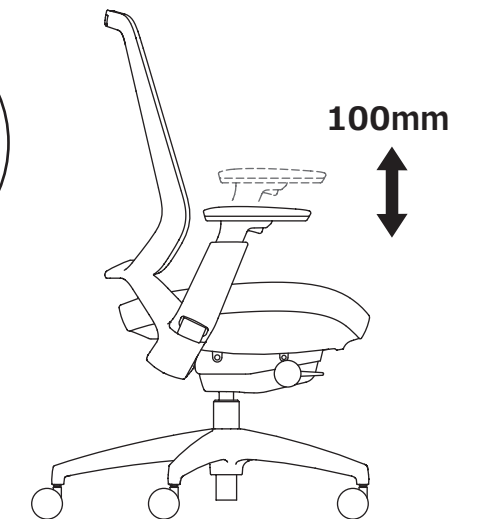
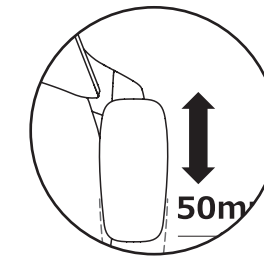
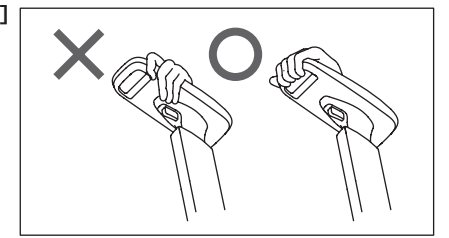
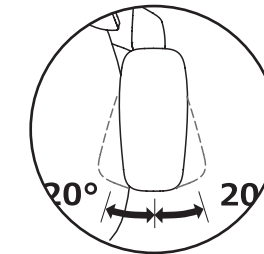

Hanger Height Adjustment (Option)

Adjust hanger height while grasping the lever in the upper portion of the hanger. Hanger height can be adjusted within a vertical range of 120 mm. The hanger can be lowered when not used, to get it out of the way and achieve a more attractive appearance.

[Direction of operation]

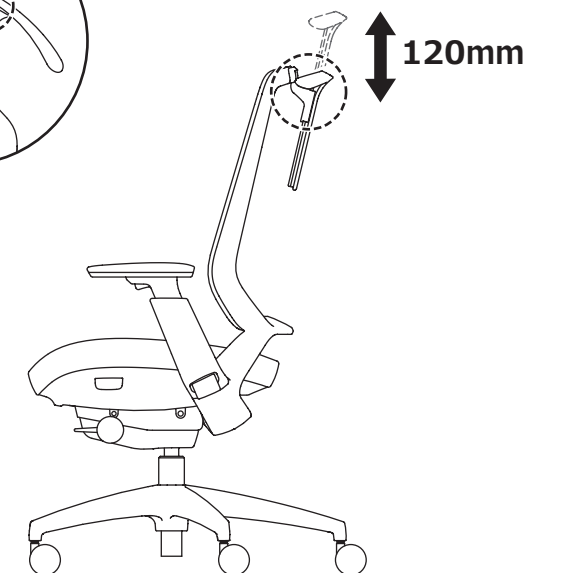
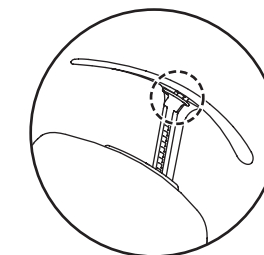

Please be careful.

- After adjustments, confirm that the hanger is securely fixed before using the chair.
- If you hang a coat or other clothing on the chair back without using the hanger (optional extra), a pocket or other part may get caught when you remove it.

4. How to use the product (continued)

Lumbar Support Height Adjustment(Optional)

Use left and right grips located behind backrest to move the lumbar support up or down. The lumbar support can be adjusted within a total vertical range of 60 mm (six levels with a pitch of 12 mm).

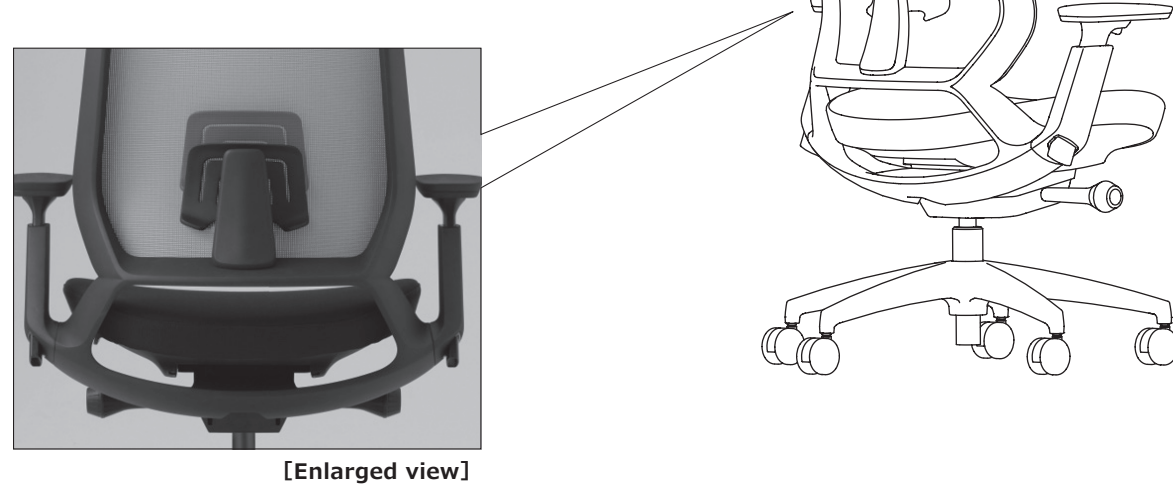

Headrest Height Adjustment(Optional)

Adjustable Headrest (2D)

Adjust the headrest height by pulling the main part of the headrest. The headrest can be moved up and down within a range of 100 mm, and the angle can be adjusted to a comfortable position within a range of 35° by moving the main part of the headrest forward.

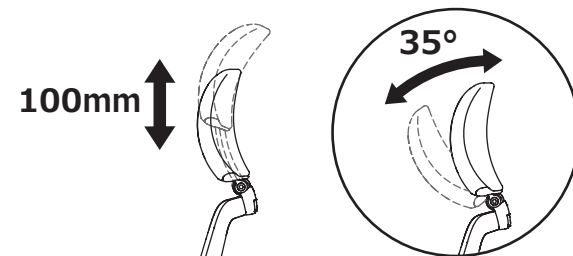

Adjustable Headrest (1D)

The 1D headrest can move up and down within a range of 80mm.

Hanger cannot be attached.

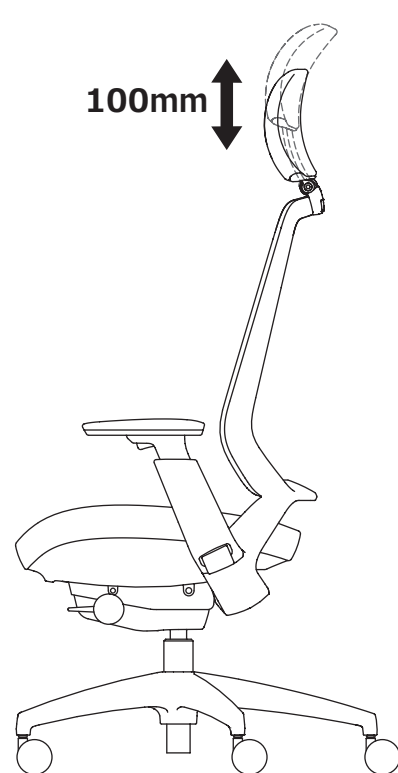
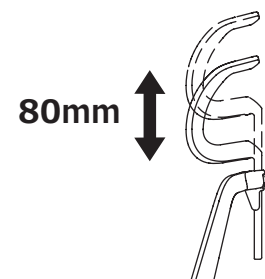

5. Daily Care Instructions

Daily care

Cloth/Mesh part

- Brush with a soft brush or tap the surface softly and vacuum to remove dust to avoid damaging the cloth.
- When it gets dirty after extended period of time, wipe with a well wrung soft cloth moistened with thin neutral detergent. Wipe clean with a damp cloth. Be sure to wipe detergent completely and wipe again with a dry cloth to dry it.
- When using alkaline electrolyzed water to remove stains, spray directly on the stain and brush with a soft brush taking care not to damage the cloth. Then, wipe the moisture and stain to remove and wait for the cloth to dry.
- When it gets an oily stain, dab and remove it by using a dedicated stain remover immediately. Then wipe with a soft cloth dampened with water, followed by a dry cloth to dry. Stains may be permanent depending on the material.

Please be careful.

- Do not leave the product with moisture remaining on it. Do not clean the product with organic solvents such as thinner or benzene, or with a cloth that contains chemicals. Be aware that once discoloration or deterioration happens, it cannot be reverted to its original state.
- Do not use hypochlorous acid water. Failure may cause the color or texture of the surface to be deteriorated.

Aluminum/Steel part

- Wipe off with a dry soft clean cloth.
- Immediately wipe off any water.
- Immediately wipe off any dust or fingerprints (sebum).

Resin Part

- Wipe with a well wrung soft cloth moistened.
- If dirt is noticeable, wipe it off with a well wrung soft cloth moistened with thin neutral detergent. Be sure to remove detergent completely with a damp cloth and wipe again with a dry cloth to dry it.

Please be careful.

- Do not rub hard. Failure will cause flashing to change the viewed color. If dirt cannot be removed, wipe it off with a soft cloth impregnated with alcohol for hand disinfection.
- Do not use any alkaline or acidic cleaning agents.

5. Daily Care Instructions (continued)

Regular Maintenance

- During use, if bolts or screws become loose, fully tighten them to extend the life of the product. Tighten as soon as possible. Do not ignore signs of loosening.
- This product is constructed so that parts which break or become worn over time can be replaced with new ones. Replace the following consumables as soon as possible when they are worn out.

Caster

Casters should be replaced when they are worn down. Irregularities that are noticeable when moving the chair, such as heaviness, caster noise, or rattling, are due to caster wear and tear. The casters should be replaced. Purchase replacement casters from your dealer.

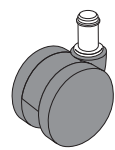

Hard caster(Nylon)

Caster outer diameter: φ60

[Replacing the casters]

Refer to the Instruction Manual supplied with the casters.

Please be careful.

- The soft wheels change over time due to the effects of hydrolysis, mold growth, ultraviolet rays, etc., causing deterioration such as crack and peeling. The speed of soft wheel aging greatly varies depending on your environment. If you find any deterioration, you are recommended to replace the wheels concerned as early as possible.
- Hard caster(Nylon wheels) may slide too well to cause the chair to fall. Use Soft caster (Urethane wheels). The nylon wheels are suited for floors covered with rugs or carpets.

After-sales Maintenance

- Upon request, we will perform periodic maintenance and cleaning so that our products can be used for a long time. For repairs, contact your dealer.
- Any product defects during the warranty period will be dealt with free of charge. Check the details of the warranty to confirm what is under warranty.
- After warranty expiration, we will perform repairs for a fee if function can be remedied by repair.

6. Troubleshooting

There are some product troubles that you may be able to solve by yourself. Please check before applying for repair.

Issue	Check	Solution
The seat cannot be lifted up.	Are you sitting on the seat when adjusting the seat height?	Adjust the seat height while not seated on the seat.
	Is the seat height in its highest position?	The seat cannot be lifted up beyond the highest position.
The seat cannot be lowered.	Are you sitting on the front edge of the seat?	Sit in the center of the seat while adjusting.
	Is the seat height in the lowest position?	The seat cannot be lowered beyond the lowest position.
Forward-back seat adjustment doesn't seem to work	Are you sitting on the seat when adjusting the seat height?	Adjust the seat height while not seated on the seat.
Backrest does not move.	Check whether the dial on the left under the seat is in the Locked state.	Turn the dial counterclockwise, and lean against the backrest.
	Check whether the reclining tension adjustment dial at the back of the seat is set to Strong.	Turn the reclining tension adjustment dial to Weak (counterclockwise).
Casters do not move smoothly.	Are they tangled with lint or wool?	Remove lint or wool or replace the casters.
Casters are slippery.	Are you using urethane casters on hard floors such as a plastic tile floor?	Use soft casters.
Abnormal sound is generated		Contact your dealer or branch service office.

7. Specification

Main Materials and Surface Finish

Part		Material		
Structural Parts	Backrest	Logo Component	Polypropylene	
		Frame	Nylon	
	Seat	Shell	Polypropylene	
		Lever	Nylon	
	Mechanism	Body	Nylon, Aluminum	
	Armrest	Adjustable Armrest	Pad	Polyurethane
			Body	Nylon
		Fixed Armrest	Pad	Polypropylene
			Body	Nylon
	Leg	Polished Leg	Aluminum	
		Black Leg	Nylon	
	Caster	Hard	Nylon	
		Soft	Polyurethane	
	Option	Hunger (Option)	Nylon	
		Headrest	Body	Polypropylene
Attachment portion			Nylon	
Lumbar Support		Polypropylene		
Upholstery	Fabric 1	Mesh	Polyester	
		Cloth	Polyester	
	Fabric 2	Mesh	Polyester	
		Cloth	Polyester	
Cushion Material	Seat	Urethane foam		
	Headrest	Urethane foam		

* Note that product specifications may change without notice in order to improve them.